



North Carolina Department of Public Instruction

INSTRUCTIONAL SUPPORT TOOLS

FOR ACHIEVING NEW STANDARDS

5th Grade Mathematics □ Unpacked Content

For the new Common Core State Standards that will be effective in all North Carolina schools in the 2012-13 school year.

This document is designed to help North Carolina educators teach the Common Core (Standard Course of Study). NCDPI staff are continually updating and improving these tools to better serve teachers.

What is the purpose of this document?

To increase student achievement by ensuring educators understand specifically what the new standards mean a student must know, understand and be able to do. This document may also be used to facilitate discussion among teachers and curriculum staff and to encourage coherence in the sequence, pacing, and units of study for grade-level curricula. This document, along with on-going professional development, is one of many resources used to understand and teach the CCSS.

What is in the document?

Descriptions of what each standard means a student will know, understand and be able to do. The “unpacking” of the standards done in this document is an effort to answer a simple question “What does this standard mean that a student must know and be able to do?” and to ensure the description is helpful, specific and comprehensive for educators.

How do I send Feedback?

We intend the explanations and examples in this document to be helpful and specific. That said, we believe that as this document is used, teachers and educators will find ways in which the unpacking can be improved and made ever more useful. Please send feedback to us at feedback@dpi.state.nc.us and we will use your input to refine our unpacking of the standards. Thank You!

Just want the standards alone?

You can find the standards alone at <http://corestandards.org/the-standards>

At A Glance

This page provides a snapshot of the mathematical concepts that are new or have been removed from this grade level as well as instructional considerations for the first year of implementation.

New to 5th Grade:

- Patterns in zeros when multiplying (5.NBT.2)
- Extend understandings of multiplication and division of fractions (5.NF.3, 5.NF.4, 5.NF.5, 5.NF.7)
- Conversions of measurements within the same system (5.MD.1)
- Volume (5.MD.3, 5.MD.4, 5.MD.5)
- Coordinate System (5.G.1, 5.G.2)
- Two-dimensional figures – hierarchy (5.G.3, 5.G.4)
- Line plot to display measurements (5.MD.2)

Moved from 5th Grade:

- Estimate measure of objects from one system to another system (2.01)
- Measure of angles (2.01)
- Describe triangles and quadrilaterals (3.01)
- Angles, diagonals, parallelism and perpendicularity (3.02, 3.04)
- Symmetry - line and rotational (3.03)
- Data - stem-and-leaf plots, different representations, median, range and mode (4.01, 4.02, 4.03)
- Constant and carrying rates of change (5.03)

Notes:

- Topics may appear to be similar between the CCSS and the 2003 NCSCOS; however, the CCSS may be presented at a higher cognitive demand.
- For more detailed information see Math Crosswalks: <http://www.dpi.state.nc.us/acre/standards/support-tools/>

Instructional considerations for CCSS implementation in 2012-2013

- Develop a fundamental understanding that the multiplication of a fraction by a whole number could be presented as repeated addition of a unit fraction (e.g., $2 \times \frac{1}{4} = \frac{1}{4} + \frac{1}{4}$) before working with the concept of a fraction times a fraction. This concept will be taught in fourth grade next year.

Standards for Mathematical Practices

The Common Core State Standards for Mathematical Practice are expected to be integrated into every mathematics lesson for all students Grades K-12. Below are a few examples of how these Practices may be integrated into tasks that students complete.

Mathematic Practices	Explanations and Examples
1. Make sense of problems and persevere in solving them.	Mathematically proficient students in grade 5 should solve problems by applying their understanding of operations with whole numbers, decimals, and fractions including mixed numbers. They solve problems related to volume and measurement conversions. Students seek the meaning of a problem and look for efficient ways to represent and solve it. They may check their thinking by asking themselves, “What is the most efficient way to solve the problem?”, “Does this make sense?”, and “Can I solve the problem in a different way?”.
2. Reason abstractly and quantitatively.	Mathematically proficient students in grade 5 should recognize that a number represents a specific quantity. They connect quantities to written symbols and create a logical representation of the problem at hand, considering both the appropriate units involved and the meaning of quantities. They extend this understanding from whole numbers to their work with fractions and decimals. Students write simple expressions that record calculations with numbers and represent or round numbers using place value concepts.
3. Construct viable arguments and critique the reasoning of others.	In fifth grade mathematically proficient students may construct arguments using concrete referents, such as objects, pictures, and drawings. They explain calculations based upon models and properties of operations and rules that generate patterns. They demonstrate and explain the relationship between volume and multiplication. They refine their mathematical communication skills as they participate in mathematical discussions involving questions like “How did you get that?” and “Why is that true?” They explain their thinking to others and respond to others’ thinking.
4. Model with mathematics.	Mathematically proficient students in grade 5 experiment with representing problem situations in multiple ways including numbers, words (mathematical language), drawing pictures, using objects, making a chart, list, or graph, creating equations, etc. Students need opportunities to connect the different representations and explain the connections. They should be able to use all of these representations as needed. Fifth graders should evaluate their results in the context of the situation and whether the results make sense. They also evaluate the utility of models to determine which models are most useful and efficient to solve problems.
5. Use appropriate tools strategically.	Mathematically proficient fifth graders consider the available tools (including estimation) when solving a mathematical problem and decide when certain tools might be helpful. For instance, they may use unit cubes to fill a rectangular prism and then use a ruler to measure the dimensions. They use graph paper to accurately create graphs and solve problems or make predictions from real world data.
6. Attend to precision.	Mathematically proficient students in grade 5 continue to refine their mathematical communication skills by using clear and precise language in their discussions with others and in their own reasoning. Students use appropriate terminology when referring to expressions, fractions, geometric figures, and coordinate grids. They are careful about specifying units of measure and state the meaning of the symbols they choose. For instance, when figuring out the volume of a rectangular prism they record their answers in cubic units.
7. Look for and make use of structure.	In fifth grade mathematically proficient students look closely to discover a pattern or structure. For instance, students use properties of operations as strategies to add, subtract, multiply and divide with whole numbers, fractions, and decimals. They examine numerical patterns and relate them to a rule or a graphical representation.
8. Look for and express regularity in repeated reasoning.	Mathematically proficient fifth graders use repeated reasoning to understand algorithms and make generalizations about patterns. Students connect place value and their prior work with operations to understand algorithms to fluently multiply multi-digit numbers and perform all operations with decimals to hundredths. Students explore operations with fractions with visual models and begin to formulate generalizations.

Grade 5 Critical Areas

The Critical Areas are designed to bring focus to the standards at each grade by describing the big ideas that educators can use to build their curriculum and to guide instruction. The Critical Areas for fifth grade can be found on page 33 in the *Common Core State Standards for Mathematics*.

1. **Developing fluency with addition and subtraction of fractions, and developing understanding of the multiplication of fractions and of division of fractions in limited cases (unit fractions divided by whole numbers and whole numbers divided by unit fractions).**

Students apply their understanding of fractions and fraction models to represent the addition and subtraction of fractions with unlike denominators as equivalent calculations with like denominators. They develop fluency in calculating sums and differences of fractions, and make reasonable estimates of them. Students also use the meaning of fractions, of multiplication and division, and the relationship between multiplication and division to understand and explain why the procedures for multiplying and dividing fractions make sense. (Note: this is limited to the case of dividing unit fractions by whole numbers and whole numbers by unit fractions.)

2. **Extending division to 2-digit divisors, integrating decimal fractions into the place value system and developing understanding of operations with decimals to hundredths, and developing fluency with whole number and decimal operations.**

Students develop understanding of why division procedures work based on the meaning of base-ten numerals and properties of operations. They finalize fluency with multi-digit addition, subtraction, multiplication, and division. They apply their understandings of models for decimals, decimal notation, and properties of operations to add and subtract decimals to hundredths. They develop fluency in these computations, and make reasonable estimates of their results. Students use the relationship between decimals and fractions, as well as the relationship between finite decimals and whole numbers (i.e., a finite decimal multiplied by an appropriate power of 10 is a whole number), to understand and explain why the procedures for multiplying and dividing finite decimals make sense. They compute products and quotients of decimals to hundredths efficiently and accurately.

3. **Developing understanding of volume.**

Students recognize volume as an attribute of three-dimensional space. They understand that volume can be measured by finding the total number of same-size units of volume required to fill the space without gaps or overlaps. They understand that a 1-unit by 1-unit by 1-unit cube is the standard unit for measuring volume. They select appropriate units, strategies, and tools for solving problems that involve estimating and measuring volume. They decompose three-dimensional shapes and find volumes of right rectangular prisms by viewing them as decomposed into layers of arrays of cubes. They measure necessary attributes of shapes in order to determine volumes to solve real world and mathematical problems.

	<p>To further develop students' understanding of grouping symbols and facility with operations, students place grouping symbols in equations to make the equations true or they compare expressions that are grouped differently.</p> <p>Example:</p> <ul style="list-style-type: none"> • $15 - 7 - 2 = 10 \rightarrow 15 - (7 - 2) = 10$ • $3 \times 125 \div 25 + 7 = 22 \rightarrow [3 \times (125 \div 25)] + 7 = 22$ • $24 \div 12 \div 6 \div 2 = 2 \times 9 + 3 \div \frac{1}{2} \rightarrow 24 \div [(12 \div 6) \div 2] = (2 \times 9) + (3 \div \frac{1}{2})$ • Compare $3 \times 2 + 5$ and $3 \times (2 + 5)$ • Compare $15 - 6 + 7$ and $15 - (6 + 7)$
<p>5.OA.2 Write simple expressions that record calculations with numbers, and interpret numerical expressions without evaluating them.</p> <p><i>For example, express the calculation “add 8 and 7, then multiply by 2” as $2 \times (8 + 7)$. Recognize that $3 \times (18932 + 921)$ is three times as large as $18932 + 921$, without having to calculate the indicated sum or product.</i></p>	<p>This standard refers to expressions. Expressions are a series of numbers and symbols (+, -, x, ÷) without an equals sign. Equations result when two expressions are set equal to each other ($2 + 3 = 4 + 1$).</p> <p>Example: $4(5 + 3)$ is an expression. When we compute $4(5 + 3)$ we are evaluating the expression. The expression equals 32. $4(5 + 3) = 32$ is an equation.</p> <p>This standard calls for students to verbally describe the relationship between expressions without actually calculating them. This standard calls for students to apply their reasoning of the four operations as well as place value while describing the relationship between numbers. The standard does not include the use of variables, only numbers and signs for operations.</p> <p>Example: Write an expression for the steps “double five and then add 26.”</p> <div data-bbox="688 846 961 915" style="border: 1px solid black; padding: 5px;"> <p>Student $(2 \times 5) + 26$</p> </div> <p>Describe how the expression $5(10 \times 10)$ relates to 10×10.</p> <div data-bbox="680 984 1896 1084" style="border: 1px solid black; padding: 5px;"> <p>Student The expression $5(10 \times 10)$ is 5 times larger than the expression 10×10 since I know that I that $5(10 \times 10)$ means that I have 5 groups of (10×10).</p> </div>

Common Core Cluster

Analyze patterns and relationships.

Mathematically proficient students communicate precisely by engaging in discussion about their reasoning using appropriate mathematical language. The terms students should learn to use with increasing precision with this cluster are: **numerical patterns, rules, ordered pairs, coordinate plane**

Common Core Standard

5.OA.3 Generate two numerical patterns using two given rules. Identify apparent relationships between corresponding terms. Form ordered pairs consisting of corresponding terms from the two patterns, and graph the ordered pairs on a coordinate plane.
For example, given the rule “Add 3” and the starting number 0, and given the rule “Add 6” and the starting number 0, generate terms in the resulting sequences, and observe that the terms in one sequence are twice the corresponding terms in the other sequence. Explain informally why this is so.

Unpacking

What do these standards mean a child will know and be able to do?

This standard extends the work from Fourth Grade, where students generate numerical patterns when they are given one rule. In Fifth Grade, students are given two rules and generate two numerical patterns. The graphs that are created should be line graphs to represent the pattern. This is a linear function which is why we get the straight lines. The Days are the independent variable, Fish are the dependent variables, and the constant rate is what the rule identifies in the table.

Example:

Make a chart (table) to represent the number of fish that Sam and Terri catch.

Days	Sam's Total Number of Fish	Terri's Total Number of Fish
0	0	0
1	2	4
2	4	8
3	6	12
4	8	16
5	10	20

Example:

Describe the pattern:

Since Terri catches 4 fish each day, and Sam catches 2 fish, the amount of Terri's fish is always greater. Terri's fish is also always twice as much as Sam's fish. Today, both Sam and Terri have no fish. They both go fishing each day. Sam catches 2 fish each day. Terri catches 4 fish each day. How many fish do they have after each of the five days? Make a graph of the number of fish.

Plot the points on a coordinate plane and make a line graph, and then interpret the graph.

Student:

My graph shows that Terri always has more fish than Sam. Terri's fish increases at a higher rate since she catches 4 fish every day. Sam only catches 2 fish every day, so his number of fish increases at a smaller rate than Terri.

Important to note as well that the lines become increasingly further apart. Identify apparent relationships between corresponding terms. Additional relationships: The two lines will never intersect; there will not be a day in which boys have the same total of fish, explain the relationship between the number of days that has passed and the number of fish a boy has ($2n$ or $4n$, n being the number of days).

Catching Fish

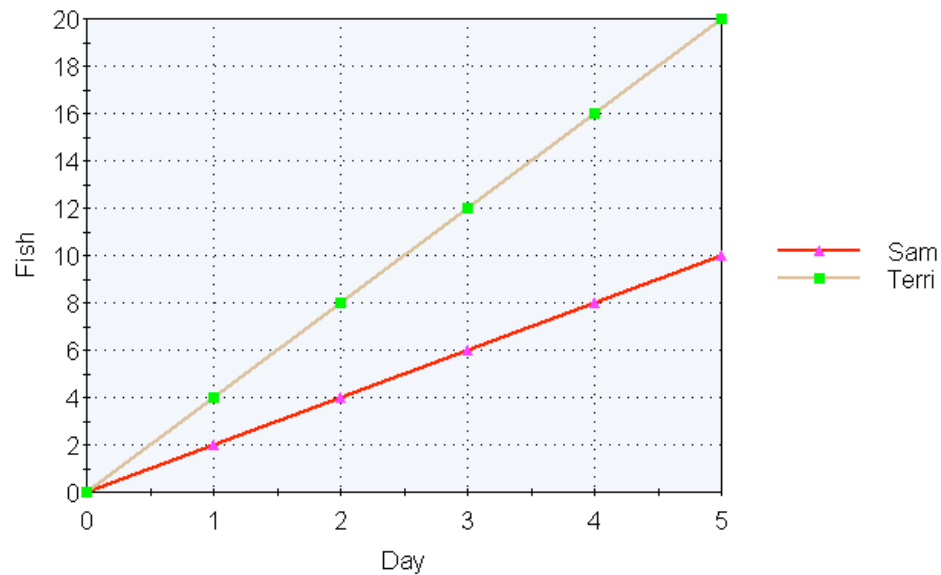

Example:

Use the rule “add 3” to write a sequence of numbers. Starting with a 0, students write 0, 3, 6, 9, 12, . . .

Use the rule “add 6” to write a sequence of numbers. Starting with 0, students write 0, 6, 12, 18, 24, . . .

After comparing these two sequences, the students notice that each term in the second sequence is twice the corresponding terms of the first sequence. One way they justify this is by describing the patterns of the terms. Their justification may include some mathematical notation (See example below). A student may explain that both sequences start with zero and to generate each term of the second sequence he/she added 6, which is twice as much as was added to produce the terms in the first sequence. Students may also use the distributive property to describe the relationship between the two numerical patterns by reasoning that $6 + 6 + 6 = 2(3 + 3 + 3)$.

0, ⁺³ 3, ⁺³ 6, ⁺³ 9, ⁺³ 12, . . .

0, ⁺⁶ 6, ⁺⁶ 12, ⁺⁶ 18, ⁺⁶ 24, . . .

Once students can describe that the second sequence of numbers is twice the corresponding terms of the first sequence, the terms can be written in ordered pairs and then graphed on a coordinate grid. They should recognize that each point on the graph represents two quantities in which the second quantity is twice the first quantity.

Ordered pairs

(0, 0)

(3, 6)

(6, 12)

(9, 18)

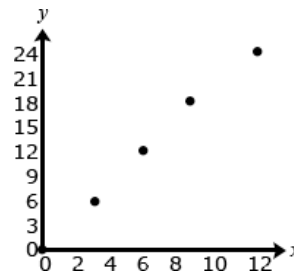

Common Core Cluster

Understand the place value system.

Mathematically proficient students communicate precisely by engaging in discussion about their reasoning using appropriate mathematical language. The terms students should learn to use with increasing precision with this cluster are: **place value, decimal, decimal point, patterns, multiply, divide, tenths, thousands, greater than, less than, equal to, <, >, =, compare/comparison, round**

Common Core Standard

Unpacking

What do these standards mean a child will know and be able to do?

5.NBT.1 Recognize that in a multi-digit number, a digit in one place represents 10 times as much as it represents in the place to its right and 1/10 of what it represents in the place to its left.

This standard calls for students to reason about the magnitude of numbers. Students should work with the idea that the tens place is ten times as much as the ones place, and the ones place is 1/10th the size of the tens place. In fourth grade, students examined the relationships of the digits in numbers for whole numbers only. This standard extends this understanding to the relationship of decimal fractions. Students use base ten blocks, pictures of base ten blocks, and interactive images of base ten blocks to manipulate and investigate the place value relationships. They use their understanding of unit fractions to compare decimal places and fractional language to describe those comparisons.

Before considering the relationship of decimal fractions, students express their understanding that in multi-digit whole numbers, a digit in one place represents 10 times what it represents in the place to its right and 1/10 of what it represents in the place to its left.

Example:

The 2 in the number 542 is different from the value of the 2 in 324. The 2 in 542 represents 2 ones or 2, while the 2 in 324 represents 2 tens or 20. Since the 2 in 324 is one place to the left of the 2 in 542 the value of the 2 is 10 times greater. Meanwhile, the 4 in 542 represents 4 tens or 40 and the 4 in 324 represents 4 ones or 4. Since the 4 in 324 is one place to the right of the 4 in 542 the value of the 4 in the number 324 is 1/10th of its value in the number 542.

Example:

A student thinks, “I know that in the number 5555, the 5 in the tens place (5555) represents 50 and the 5 in the hundreds place (5555) represents 500. So a 5 in the hundreds place is ten times as much as a 5 in the tens place or a 5 in the tens place is 1/10 of the value of a 5 in the hundreds place.

Base on the base-10 number system digits to the left are times as great as digits to the right; likewise, digits to the right are 1/10th of digits to the left. For example, the 8 in 845 has a value of 800 which is ten times as much as the 8 in the number 782. In the same spirit, the 8 in 782 is 1/10th the value of the 8 in 845.

To extend this understanding of place value to their work with decimals, students use a model of one unit; they cut it into 10 equal pieces, shade in, or describe $1/10$ of that model using fractional language (“This is 1 out of 10 equal parts. So it is $1/10$ ”. I can write this using $1/10$ or 0.1”). They repeat the process by finding $1/10$ of a $1/10$ (e.g., dividing $1/10$ into 10 equal parts to arrive at $1/100$ or 0.01) and can explain their reasoning, “0.01 is $1/10$ of $1/10$ thus is $1/100$ of the whole unit.”

In the number 55.55, each digit is 5, but the value of the digits is different because of the placement.

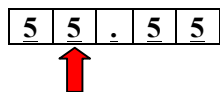

The 5 that the arrow points to is $1/10$ of the 5 to the left and 10 times the 5 to the right. The 5 in the ones place is $1/10$ of 50 and 10 times five tenths.

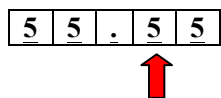

The 5 that the arrow points to is $1/10$ of the 5 to the left and 10 times the 5 to the right. The 5 in the tenths place is 10 times five hundredths.

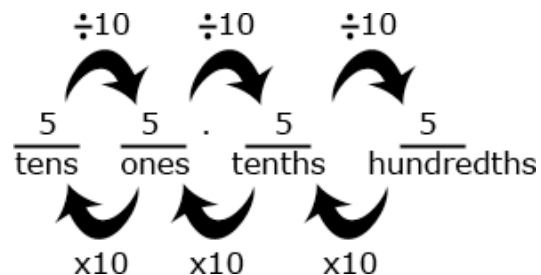

5.NBT.2 Explain patterns in the number of zeros of the product when multiplying a number by powers of 10, and explain patterns in the placement of the decimal point when a decimal is multiplied or divided by a power of 10. Use whole-number exponents to denote powers of 10.

This standard includes multiplying by multiples of 10 and powers of 10, including 10^2 which is $10 \times 10 = 100$, and 10^3 which is $10 \times 10 \times 10 = 1,000$. Students should have experiences working with connecting the pattern of the number of zeros in the product when you multiply by powers of 10.

Example:

$2.5 \times 10^3 = 2.5 \times (10 \times 10 \times 10) = 2.5 \times 1,000 = 2,500$ Students should reason that the exponent above the 10 indicates how many places the decimal point is moving (not just that the decimal point is moving but that you are multiplying or making the number 10 times greater three times) when you multiply by a power of 10. Since we are multiplying by a power of 10 the decimal point moves to the right.

$$350 \div 10^3 = 350 \div 1,000 = 0.350 = 0.35 \quad 350/10 = 35, 35/10 = 3.5 \quad 3.5/10 = 0.35, \text{ or } 350 \times 1/10, 35 \times 1/10,$$

	<p>$3.5 \times 1/10$ this will relate well to subsequent work with operating with fractions. This example shows that when we divide by powers of 10, the exponent above the 10 indicates how many places the decimal point is moving (how many times we are dividing by 10, the number becomes ten times smaller). Since we are dividing by powers of 10, the decimal point moves to the left.</p> <p>Students need to be provided with opportunities to explore this concept and come to this understanding; this should not just be taught procedurally.</p> <p>Example: Students might write:</p> <ul style="list-style-type: none"> • $36 \times 10 = 36 \times 10^1 = 360$ • $36 \times 10 \times 10 = 36 \times 10^2 = 3600$ • $36 \times 10 \times 10 \times 10 = 36 \times 10^3 = 36,000$ • $36 \times 10 \times 10 \times 10 \times 10 = 36 \times 10^4 = 360,000$ <p>Students might think and/or say:</p> <ul style="list-style-type: none"> • I noticed that every time, I multiplied by 10 I added a zero to the end of the number. That makes sense because each digit's value became 10 times larger. To make a digit 10 times larger, I have to move it one place value to the left. • When I multiplied 36 by 10, the 30 became 300. The 6 became 60 or the 36 became 360. So I had to add a zero at the end to have the 3 represent 3 one-hundreds (instead of 3 tens) and the 6 represents 6 tens (instead of 6 ones). <p>Students should be able to use the same type of reasoning as above to explain why the following multiplication and division problem by powers of 10 make sense.</p> <ul style="list-style-type: none"> • $523 \times 10^3 = 523,000$ The place value of 523 is increased by 3 places. • $5.223 \times 10^2 = 522.3$ The place value of 5.223 is increased by 2 places. • $52.3 \div 10^1 = 5.23$ The place value of 52.3 is decreased by one place.
<p>5.NBT.3 Read, write, and compare decimals to thousandths.</p> <p>a. Read and write decimals to thousandths using base-ten numerals, number names, and expanded form, e.g., $347.392 = 3 \times 100 + 4 \times 10 + 7 \times 1 + 3 \times (1/10) + 9 \times (1/100) + 2 \times (1/1000)$</p>	<p>This standard references expanded form of decimals with fractions included. Students should build on their work from Fourth Grade, where they worked with both decimals and fractions interchangeably. Expanded form is included to build upon work in 5.NBT.2 and deepen students' understanding of place value.</p> <p>Students build on the understanding they developed in fourth grade to read, write, and compare decimals to thousandths. They connect their prior experiences with using decimal notation for fractions and addition of fractions with denominators of 10 and 100. They use concrete models and number lines to extend this understanding to decimals to the thousandths. Models may include base ten blocks, place value charts, grids, pictures, drawings, manipulatives, technology-based, etc. They read decimals using fractional language and write decimals in fractional form, as well as in expanded notation. This investigation leads them to understanding equivalence of decimals ($0.8 = 0.80 = 0.800$).</p>

- b. Compare two decimals to thousandths based on meanings of the digits in each place, using $>$, $=$, and $<$ symbols to record the results of comparisons.

Comparing decimals builds on work from fourth grade.

Example:

Some equivalent forms of 0.72 are:

$$\begin{array}{ll} 72/100 & 70/100 + 2/100 \\ 7/10 + 2/100 & 0.720 \\ 7 \times (1/10) + 2 \times (1/100) & 7 \times (1/10) + 2 \times (1/100) + 0 \times (1/1000) \\ 0.70 + 0.02 & 720/1000 \end{array}$$

Students need to understand the size of decimal numbers and relate them to common benchmarks such as 0, 0.5 (0.50 and 0.500), and 1. Comparing tenths to tenths, hundredths to hundredths, and thousandths to thousandths is simplified if students use their understanding of fractions to compare decimals.

Example:

Comparing 0.25 and 0.17, a student might think, “25 hundredths is more than 17 hundredths”. They may also think that it is 8 hundredths more. They may write this comparison as $0.25 > 0.17$ and recognize that $0.17 < 0.25$ is another way to express this comparison.

Comparing 0.207 to 0.26, a student might think, “Both numbers have 2 tenths, so I need to compare the hundredths. The second number has 6 hundredths and the first number has no hundredths so the second number must be larger. Another student might think while writing fractions, “I know that 0.207 is 207 thousandths (and may write 207/1000). 0.26 is 26 hundredths (and may write 26/100) but I can also think of it as 260 thousandths (260/1000). So, 260 thousandths is more than 207 thousandths.

- 5.NBT.4** Use place value understanding to round decimals to any place.

This standard refers to rounding. Students should go beyond simply applying an algorithm or procedure for rounding. The expectation is that students have a deep understanding of place value and number sense and can explain and reason about the answers they get when they round. Students should have numerous experiences using a number line to support their work with rounding.

Example:

Round 14.235 to the nearest tenth.

Students recognize that the possible answer must be in tenths thus, it is either 14.2 or 14.3. They then identify that 14.235 is closer to 14.2 (14.20) than to 14.3 (14.30).

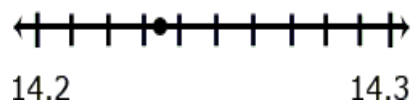

Students should use benchmark numbers to support this work. Benchmarks are convenient numbers for comparing and rounding numbers. 0., 0.5, 1, 1.5 are examples of benchmark numbers.

Example:
Which benchmark number is the best estimate of the shaded amount in the model below? Explain your thinking.

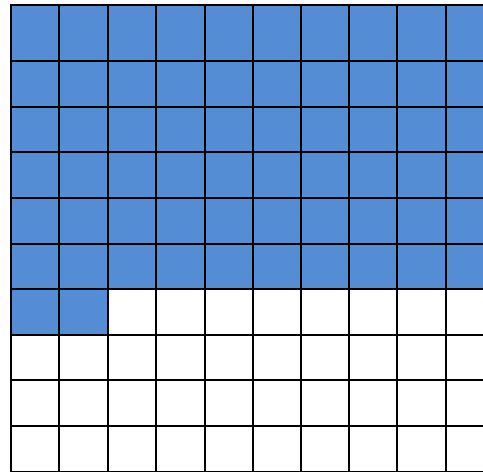

Common Core Cluster

Perform operations with multi-digit whole numbers and with decimals to hundredths.

Students develop understanding of why division procedures work based on the meaning of base-ten numerals and properties of operations. They finalize fluency with multi-digit addition, subtraction, multiplication, and division. They apply their understandings of models for decimals, decimal notation, and properties of operations to add and subtract decimals to hundredths. They develop fluency in these computations, and make reasonable estimates of their results. Students use the relationship between decimals and fractions, as well as the relationship between finite decimals and whole numbers (i.e., a finite decimal multiplied by an appropriate power of 10 is a whole number), to understand and explain why the procedures for multiplying and dividing finite decimals make sense. They compute products and quotients of decimals to hundredths efficiently and accurately.

Mathematically proficient students communicate precisely by engaging in discussion about their reasoning using appropriate mathematical language. The terms students should learn to use with increasing precision with this cluster are: **multiplication/multiply, division/division, decimal, decimal point, tenths, hundredths, products, quotients, dividends, rectangular arrays, area models, addition/add, subtraction/subtract, (properties)-rules about how numbers work, reasoning**

Common Core Standard

Unpacking

What do these standards mean a child will know and be able to do?

5.NBT.5 Fluently multiply multi-digit whole numbers using the standard algorithm.

This standard refers to fluency which means accuracy (correct answer), efficiency (a reasonable amount of steps), and flexibility (using strategies such as the distributive property or breaking numbers apart also using strategies according to the numbers in the problem, 26×4 may lend itself to $(25 \times 4) + 4$ where as another problem might lend itself to making an equivalent problem $32 \times 4 = 64 \times 2$). This standard builds upon students' work with multiplying numbers in third and fourth

grade. In fourth grade, students developed understanding of multiplication through using various strategies. While the standard algorithm is mentioned, alternative strategies are also appropriate to help students develop conceptual understanding. The size of the numbers should NOT exceed a three-digit factor by a two-digit factor.

Examples of alternative strategies:

There are 225 dozen cookies in the bakery. How many cookies are there?

Student 1
 225×12
 I broke 12 up into 10 and 2.
 $225 \times 10 = 2,250$
 $225 \times 2 = 450$
 $2,250 + 450 = 2,700$

Student 2
 225×12
 I broke up 225 into 200 and 25.
 $200 \times 12 = 2,400$
 I broke 25 up into 5×5 , so I had $5 \times 5 \times 12$ or $5 \times 12 \times 5$.
 $5 \times 12 = 60$. $60 \times 5 = 300$
 I then added 2,400 and 300
 $2,400 + 300 = 2,700$.

Student 3
 I doubled 225 and cut 12 in half to get 450×6 . I then doubled 450 again and cut 6 in half to get 900×3 .
 $900 \times 3 = 2,700$.

Draw an array model for 225×12 200×10 , 200×2 , 20×10 , 20×2 , 5×10 , 5×2

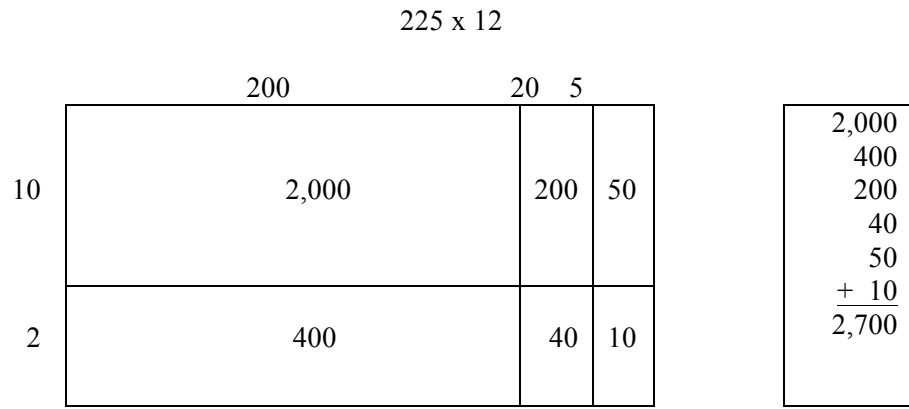

5.NBT.6 Find whole-number quotients of whole numbers with up to four-digit dividends

This standard references various strategies for division. Division problems can include remainders. Even though this standard leads more towards computation, the connection to story contexts is critical. Make sure students are exposed to problems where the divisor is the number of groups and where the divisor is the size of the groups. In fourth grade, students' experiences with division were limited to dividing by one-digit divisors. This standard extends students' prior experiences

and two-digit divisors, using strategies based on place value, the properties of operations, and/or the relationship between multiplication and division. Illustrate and explain the calculation by using equations, rectangular arrays, and/or area models.

with strategies, illustrations, and explanations. When the two-digit divisor is a “familiar” number, a student might decompose the dividend using place value.

Example:

There are 1,716 students participating in Field Day. They are put into teams of 16 for the competition. How many teams get created? If you have left over students, what do you do with them?

Student 1
 1,716 divided by 16
 There are 100 16's in 1,716.
 $1,716 - 1,600 = 116$
 I know there are at least 6 16's.
 $116 - 96 = 20$
 I can take out at least 1 more 16.
 $20 - 16 = 4$
 There were 107 teams with 4 students left over. If we put the extra students on different team, 4 teams will have 17 students.

Student 2
 1,716 divided by 16.
 There are 100 16's in 1,716.

1716	
-1600	100
116	
-80	5
36	
-32	2
4	

Ten groups of 16 is 160.
 That's too big.
 Half of that is 80, which is 5 groups.
 I know that 2 groups of 16's is 32.
 I have 4 students left over.

Student 3
 $1,716 \div 16 =$
 I want to get to 1,716
 I know that 100 16's equals 1,600
 I know that 5 16's equals 80
 $1,600 + 80 = 1,680$
 Two more groups of 16's equals 32, which gets us to 1,712
 I am 4 away from 1,716
 So we had $100 + 6 + 1 = 107$ teams
 Those other 4 students can just hang out

Student 4
 How many 16's are in 1,716?
 We have an area of 1,716. I know that one side of my array is 16 units long. I used 16 as the height. I am trying to answer the question what is the width of my rectangle if the area is 1,716 and the height is 16. $100 + 7 = 107$ R 4

	100	7
16	$100 \times 16 = 1,600$	$7 \times 16 = 112$

$1,716 - 1,600 = 116$

$116 - 112 = 4$

Example:

Using expanded notation $2682 \div 25 = (2000 + 600 + 80 + 2) \div 25$

Using understanding of the relationship between 100 and 25, a student might think ~

- I know that 100 divided by 25 is 4 so 200 divided by 25 is 8 and 2000 divided by 25 is 80.
- 600 divided by 25 has to be 24.
- Since 3×25 is 75, I know that 80 divided by 25 is 3 with a remainder of 5.
(Note that a student might divide into 82 and not 80)
- I can't divide 2 by 25 so 2 plus the 5 leaves a remainder of 7.
- $80 + 24 + 3 = 107$. So, the answer is 107 with a remainder of 7.

Using an equation that relates division to multiplication, $25 \times n = 2682$, a student might estimate the answer to be slightly larger than 100 because s/he recognizes that $25 \times 100 = 2500$.

Example: $968 \div 21$

Using base ten models, a student can represent 962 and use the models to make an array with one dimension of 21. The student continues to make the array until no more groups of 21 can be made. Remainders are not part of the array.

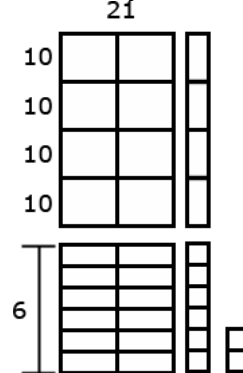

Example: $9984 \div 64$

An area model for division is shown below. As the student uses the area model, s/he keeps track of how much of the 9984 is left to divide.

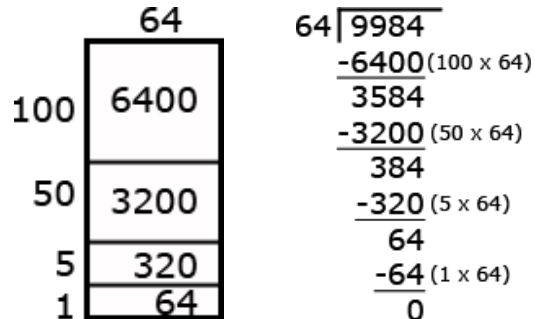

5.NBT.7 Add, subtract, multiply, and divide decimals to hundredths, using concrete models or drawings and strategies based on place value, properties of operations, and/or the relationship between addition and subtraction; relate the strategy to a written method and explain the reasoning used.

This standard builds on the work from fourth grade where students are introduced to decimals and compare them. In fifth grade, students begin adding, subtracting, multiplying and dividing decimals. This work should focus on concrete models and pictorial representations, rather than relying solely on the algorithm. The use of symbolic notations involves having students record the answers to computations ($2.25 \times 3 = 6.75$), but this work should not be done without models or pictures. This standard includes students' reasoning and explanations of how they use models, pictures, and strategies.

This standard requires students to extend the models and strategies they developed for whole numbers in grades 1-4 to decimal values. Before students are asked to give exact answers, they should estimate answers based on their understanding of operations and the value of the numbers.

Examples:

- $3.6 + 1.7$

A student might estimate the sum to be larger than 5 because 3.6 is more than $3 \frac{1}{2}$ and 1.7 is more than $1 \frac{1}{2}$.

- $5.4 - 0.8$

A student might estimate the answer to be a little more than 4.4 because a number less than 1 is being subtracted.

- 6×2.4

A student might estimate an answer between 12 and 18 since 6×2 is 12 and 6×3 is 18. Another student might give an estimate of a little less than 15 because s/he figures the answer to be very close, but smaller than $6 \times 2 \frac{1}{2}$ and think of $2 \frac{1}{2}$ groups of 6 as 12 (2 groups of 6) + 3 ($\frac{1}{2}$ of a group of 6).

Students should be able to express that when they add decimals they add tenths to tenths and hundredths to hundredths. So, when they are adding in a vertical format (numbers beneath each other), it is important that they write numbers with the same place value beneath each other. This understanding can be reinforced by connecting addition of decimals to their understanding of addition of fractions. Adding fractions with denominators of 10 and 100 is a standard in fourth grade.

Example: $4 - 0.3$

3 tenths subtracted from 4 wholes. The wholes must be divided into tenths.

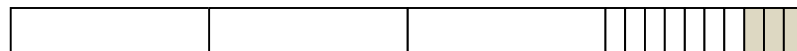

The solution is 3 and $\frac{7}{10}$ or 3.7.

Additional examples on next page.

Example:

A recipe for a cake requires 1.25 cups of milk, 0.40 cups of oil, and 0.75 cups of water. How much liquid is in the mixing bowl?

Student 1

$$1.25 + 0.40 + 0.75$$

First, I broke the numbers apart:

I broke 1.25 into $1.00 + 0.20 + 0.05$

I left 0.40 like it was.

I broke 0.75 into $0.70 + 0.05$

I combined my two 0.05s to get 0.10.

I combined 0.40 and 0.20 to get 0.60.

I added the 1 whole from 1.25.

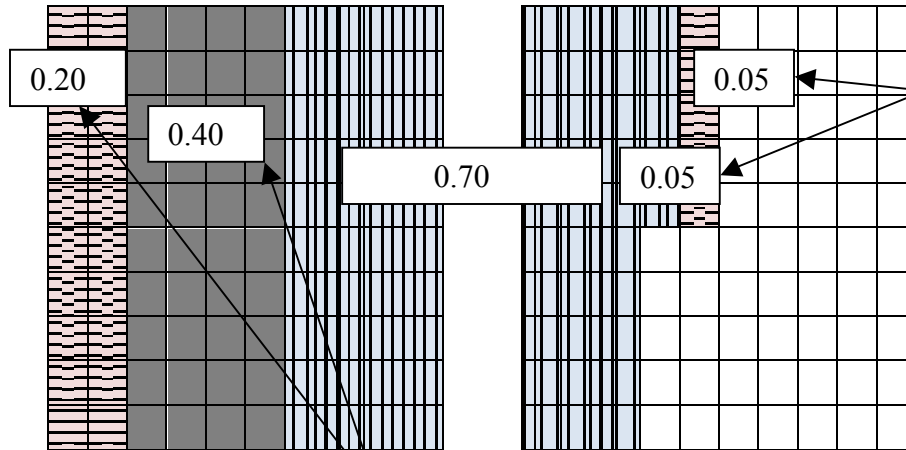
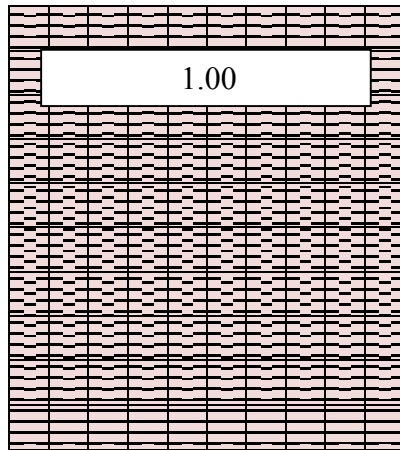

I ended up with 1 whole, 6 tenths, 7 more tenths and 1 hundredth
 $0.05 + 0.05 = 0.10$ is 2.40

$$0.40 + 0.20 = 0.60$$

Student 2

I saw that the 0.25 in 1.25 and the 0.75 for water would combine to equal 1 whole.

I then added the 2 wholes and the 0.40 to get 2.40.

$$.25 + .75 + 1 + .40 = 2.40$$

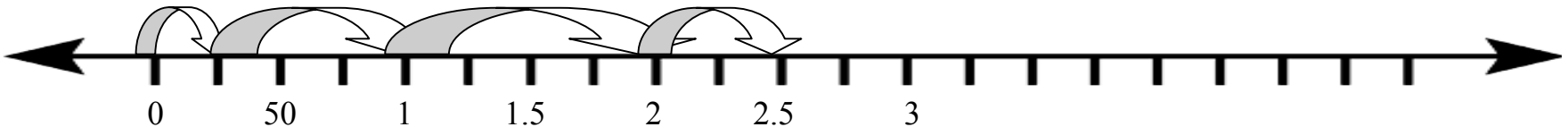

Example of Multiplication:

A gumball costs \$0.22. How much do 5 gumballs cost? Estimate the total, and then calculate. Was your estimate close?

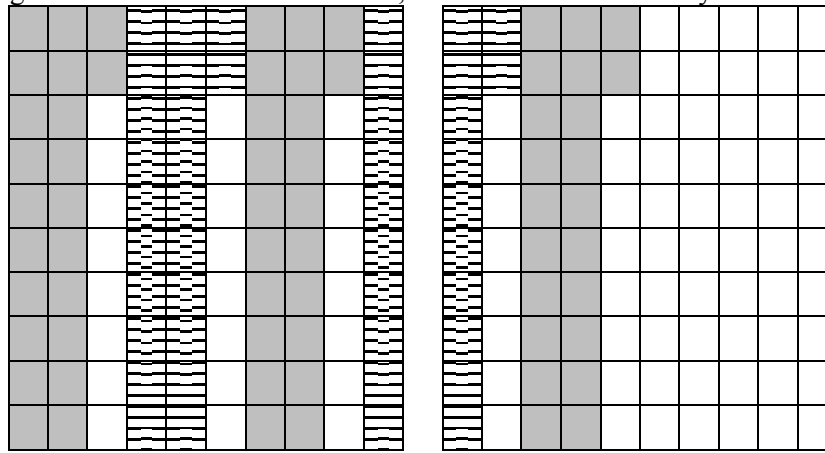

I estimate that the total cost will be a little more than a dollar. I know that 5 20's equal 100 and we have 5 22's.

I have 10 whole columns shaded and 10 individual boxes shaded. The 10 columns equal 1 whole. The 10 individual boxes equal 10 hundredths or 1 tenth. My answer is \$1.10.

My estimate was a little more than a dollar, and my answer was \$1.10. I was really close.

Example of Division:

A relay race lasts 4.65 miles. The relay team has 3 runners. If each runner goes the same distance, how far does each team member run? Make an estimate, find your actual answer, and then compare them.

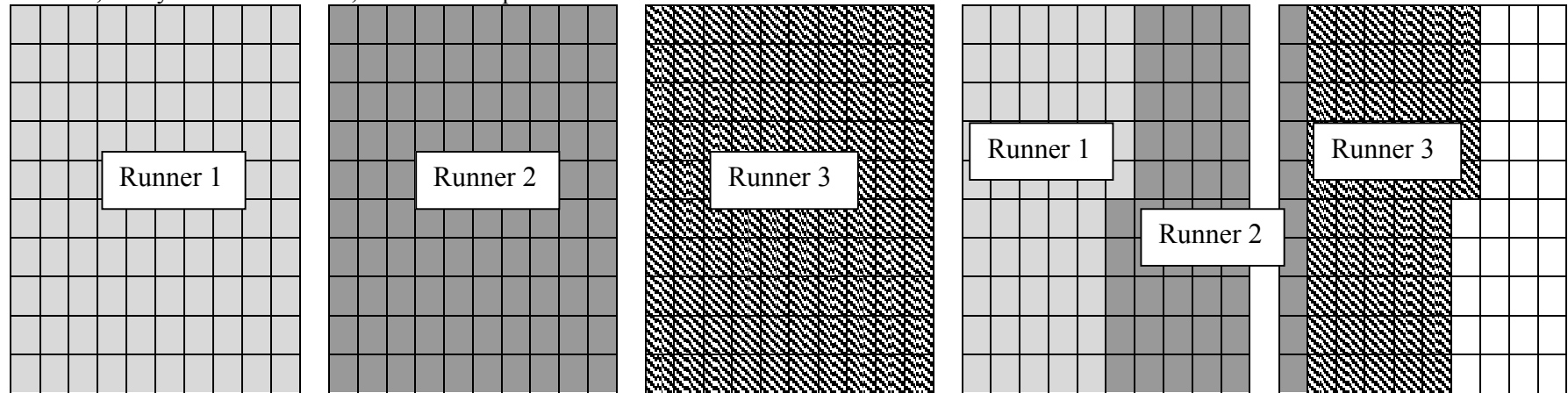

My estimate is that each runner runs between 1 and 2 miles. If each runner went 2 miles, that would be a total of 6 miles which is too high. If each runner ran 1 mile, that would be 3 miles, which is too low.

I used the 5 grids above to represent the 4.65 miles. I am going to use all of the first 4 grids and 65 of the squares in the 5th grid. I have to divide the 4

whole grids and the 65 squares into 3 equal groups. I labeled each of the first 3 grids for each runner, so I know that each team member ran at least 1 mile. I then have 1 whole grid and 65 squares to divide up. Each column represents one-tenth. If I give 5 columns to each runner, that means that each runner has run 1 whole mile and 5 tenths of a mile. Now, I have 15 squares left to divide up. Each runner gets 5 of those squares. So each runner ran 1 mile, 5 tenths and 5 hundredths of a mile. I can write that as 1.55 miles.

My answer is 1.55 and my estimate was between 1 and 2 miles. I was pretty close.

Additional multiplication and division examples:

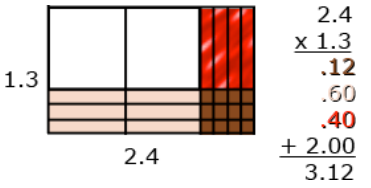
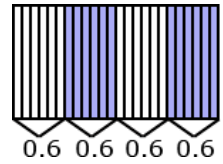
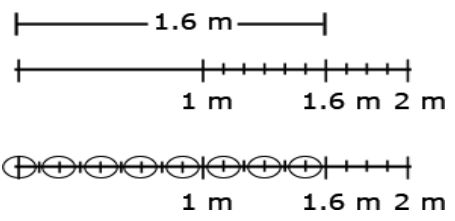
<p>An area model can be useful for illustrating products.</p> 	<p>Students should be able to describe the partial products displayed by the area model.</p> <p>For example, “3/10 times 4/10 is 12/100. 3/10 times 2 is 6/10 or 60/100. 1 group of 4/10 is 4/10 or 40/100. 1 group of 2 is 2.”</p>
<p>Example of division: finding the number in each group or share. Students should be encouraged to apply a fair sharing model separating decimal values into equal parts such as $2.4 \div 4 = 0.6$</p> 	<p>Example of division: finding the number of groups.</p> <p>Joe has 1.6 meters of rope. He has to cut pieces of rope that are 0.2 meters long. How many can he cut?</p>
<p>Example of division: finding the number of groups. Students could draw a segment to represent 1.6 meters. In doing so, s/he would count in tenths to identify the 6 tenths, and be able identify the number of 2 tenths within the 6 tenths. The student can then extend the idea of counting by tenths to divide the one meter into tenths and determine that there are 5 more groups of 2 tenths.</p> 	<p>Students might count groups of 2 tenths without the use of models or diagrams. Knowing that 1 can be thought of as 10/10, a student might think of 1.6 as 16 tenths. Counting 2 tenths, 4 tenths, 6 tenths, . . . 16 tenths, a student can count 8 groups of 2 tenths.</p> <p>Use their understanding of multiplication and think, “8 groups of 2 is 16, so 8 groups of 2/10 is 16/10 or 1 6/10.”</p>

Common Core Cluster

Use equivalent fractions as a strategy to add and subtract fractions.

Students apply their understanding of fractions and fraction models to represent the addition and subtraction of fractions with unlike denominators as equivalent calculations with like denominators. They develop fluency in calculating sums and differences of fractions, and make reasonable estimates of them.

Mathematically proficient students communicate precisely by engaging in discussion about their reasoning using appropriate mathematical language. The terms students should learn to use with increasing precision with this cluster are: **fraction, equivalent, addition/ add, sum, subtraction/subtract, difference, unlike denominator, numerator, benchmark fraction, estimate, reasonableness, mixed numbers**

Common Core Standard	Unpacking What do these standards mean a child will know and be able to do?
<p>5.NF.1 Add and subtract fractions with unlike denominators (including mixed numbers) by replacing given fractions with equivalent fractions in such a way as to produce an equivalent sum or difference of fractions with like denominators.</p> <p><i>For example, $2/3 + 5/4 = 8/12 + 15/12 = 23/12$. (In general, $a/b + c/d = (ad + bc)/bd$.)</i></p>	<p>5.NF.1 builds on the work in fourth grade where students add fractions with like denominators. In fifth grade, the example provided in the standard has students find a common denominator by finding the product of both denominators. For $1/3 + 1/6$, a common denominator is 18, which is the product of 3 and 6. This process should be introduced using visual fraction models (area models, number lines, etc.) to build understanding before moving into the standard algorithm.</p> <p>Students should apply their understanding of equivalent fractions and their ability to rewrite fractions in an equivalent form to find common denominators. They should know that multiplying the denominators will always give a common denominator but may not result in the smallest denominator.</p> <p>Examples:</p> $\frac{2}{5} + \frac{7}{8} = \frac{16}{40} + \frac{35}{40} = \frac{51}{40}$ $3\frac{1}{4} - \frac{1}{6} = 3\frac{3}{12} - \frac{2}{12} = 3\frac{1}{12}$ <p>Example: Present students with the problem $1/3 + 1/6$. Encourage students to use the clock face as a model for solving the problem. Have students share their approaches with the class and demonstrate their thinking using the clock model.</p>

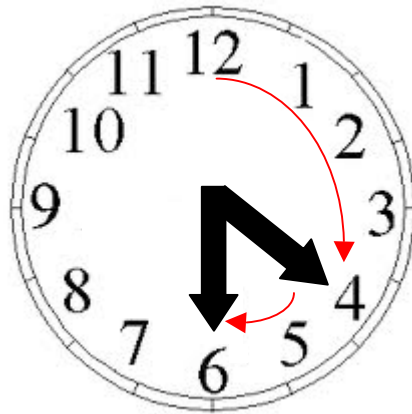

5.NF.2 Solve word problems involving addition and subtraction of fractions referring to the same whole, including cases of unlike denominators, e.g., by using visual fraction models or equations to represent the problem. Use benchmark fractions and number sense of fractions to estimate mentally and assess the reasonableness of answers. *For example, recognize an incorrect result $2/5 + 1/2 = 3/7$, by observing that $3/7 < 1/2$.*

This standard refers to number sense, which means students' understanding of fractions as numbers that lie between whole numbers on a number line. Number sense in fractions also includes moving between decimals and fractions to find equivalents, also being able to use reasoning such as $7/8$ is greater than $3/4$ because $7/8$ is missing only $1/8$ and $3/4$ is missing $1/4$ so $7/8$ is closer to a whole. Also, students should use benchmark fractions to estimate and examine the reasonableness of their answers. Example here such as $5/8$ is greater than $6/10$ because $5/8$ is $1/8$ larger than $1/2$ ($4/8$) and $6/10$ is only $1/10$ larger than $1/2$ ($5/10$)

Example:

Your teacher gave you $1/7$ of the bag of candy. She also gave your friend $1/3$ of the bag of candy. If you and your friend combined your candy, what fraction of the bag would you have? Estimate your answer and then calculate. How reasonable was your estimate?

Student 1

$1/7$ is really close to 0. $1/3$ is larger than $1/7$, but still less than $1/2$. If we put them together we might get close to $1/2$.

$1/7 + 1/3 = 3/21 + 7/21 = 10/21$. The fraction does not simplify. I know that 10 is half of 20, so $10/21$ is a little less than $1/2$.

Another example: $1/7$ is close to $1/6$ but less than $1/6$, and $1/3$ is equivalent to $2/6$, so I have a little less than $3/6$ or $1/2$.

Example:

Jerry was making two different types of cookies. One recipe needed $3/4$ cup of sugar and the other needed $2/3$ cup of sugar. How much sugar did he need to make both recipes?

- Mental estimation:

A student may say that Jerry needs more than 1 cup of sugar but less than 2 cups. An explanation may compare both fractions to $\frac{1}{2}$ and state that both are larger than $\frac{1}{2}$ so the total must be more than 1. In addition, both fractions are slightly less than 1 so the sum cannot be more than 2.

- Area model

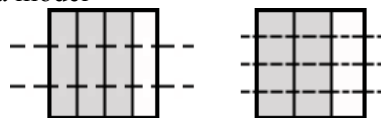

$\frac{3}{4}$ cup
of sugar

$$\frac{3}{4} = \frac{9}{12}$$

$\frac{2}{3}$ cup
of sugar

$$\frac{2}{3} = \frac{8}{12}$$

$$\frac{3}{4} + \frac{2}{3} = \frac{17}{12} = \frac{12}{12} + \frac{5}{12} = 1\frac{5}{12}$$

- Linear model

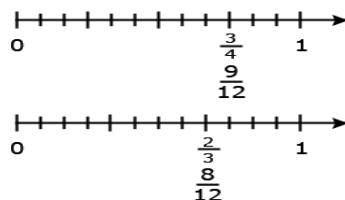

Solution:

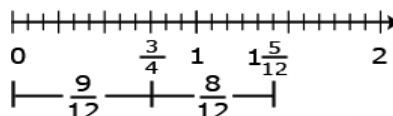

Example: Using a bar diagram

- Sonia had $2\frac{1}{3}$ candy bars. She promised her brother that she would give him $\frac{1}{2}$ of a candy bar. How much will she have left after she gives her brother the amount she promised?
- If Mary ran 3 miles every week for 4 weeks, she would reach her goal for the month. The first day of the first week she ran $1\frac{3}{4}$ miles. How many miles does she still need to run the first week?
 - Using addition to find the answer: $1\frac{3}{4} + n = 3$
 - A student might add $1\frac{1}{4}$ to $1\frac{3}{4}$ to get to 3 miles. Then he or she would add $\frac{1}{6}$ more. Thus $1\frac{1}{4}$ miles + $\frac{1}{6}$ of a mile is what Mary needs to run during that week.

Example: Using an area model to subtract

- This model shows $1\frac{3}{4}$ subtracted from $3\frac{1}{6}$ leaving $1 + \frac{1}{4} = \frac{5}{4}$ which a student can then change to $1 + \frac{3}{12} + \frac{2}{12} = 1\frac{5}{12}$. $3\frac{1}{6}$ can be expressed with a denominator of 12. Once this is done a student can complete the problem, $2\frac{14}{12} - 1\frac{9}{12} = 1\frac{5}{12}$.

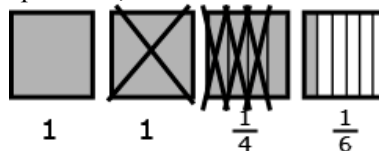

- This diagram models a way to show how $3\frac{1}{6}$ and $1\frac{3}{4}$ can be expressed with a denominator of 12. Once this is accomplished, a student can complete the problem, $2\frac{14}{12} - 1\frac{9}{12} = 1\frac{5}{12}$.

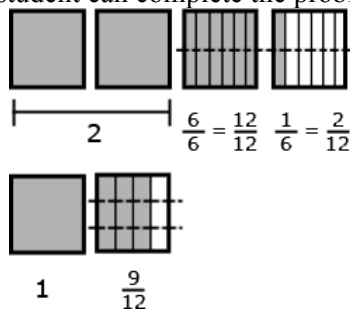

Estimation skills include identifying when estimation is appropriate, determining the level of accuracy needed, selecting the appropriate method of estimation, and verifying solutions or determining the reasonableness of situations using various estimation strategies. Estimation strategies for calculations with fractions extend from students' work with whole number operations and can be supported through the use of physical models.

Example:

Elli drank $\frac{3}{5}$ quart of milk and Javier drank $\frac{1}{10}$ of a quart less than Ellie.

How much milk did they drink all together?

Solution:

$$\frac{3}{5} - \frac{1}{10} = \frac{6}{10} - \frac{1}{10} = \frac{5}{10}$$

This is how much milk Javier drank.

$$\frac{3}{5} + \frac{5}{10} = \frac{6}{10} + \frac{5}{10} = \frac{11}{10}$$

Together they drank $1\frac{1}{10}$ quarts of milk.

This solution is reasonable because Ellie drank more than $\frac{1}{2}$ quart and Javier drank $\frac{1}{2}$ quart so together they drank slightly more than one quart.

Common Core Cluster

Apply and extend previous understandings of multiplication and division to multiply and divide fractions.

Students also use the meaning of fractions, of multiplication and division, and the relationship between multiplication and division to understand and explain why the procedures for multiplying and dividing fractions make sense. (Note: this is limited to the case of dividing unit fractions by whole numbers and whole numbers by unit fractions.)

Mathematically proficient students communicate precisely by engaging in discussion about their reasoning using appropriate mathematical language. The terms students should learn to use with increasing precision with this cluster are: **fraction, numerator, denominator, operations, multiplication/multiply, division/divide, mixed numbers, product, quotient, partition, equal parts, equivalent, factor, unit fraction, area, side lengths, fractional sides lengths, scaling, comparing**

Common Core Standard	Unpacking What does this standards mean a child will know and be able to do?
<p>5.NF.3 Interpret a fraction as division of the numerator by the denominator ($a/b = a \div b$). Solve word problems involving division of whole numbers leading to answers in the form of fractions or mixed numbers, e.g., by using visual fraction models or equations to represent the problem.</p> <p><i>For example, interpret $3/4$ as the result of dividing 3 by 4, noting that $3/4$ multiplied by 4 equals 3, and that when 3 wholes are shared equally among 4 people each person has a share of size $3/4$. If 9 people want to share a 50-pound sack of rice equally by weight, how many pounds of rice should each person get? Between what two whole numbers does your answer lie?</i></p>	<p>This standard calls for students to extend their work of partitioning a number line from third and fourth grade. Students need ample experiences to explore the concept that a fraction is a way to represent the division of two quantities.</p> <p>Students are expected to demonstrate their understanding using concrete materials, drawing models, and explaining their thinking when working with fractions in multiple contexts. They read $3/5$ as “three fifths” and after many experiences with sharing problems, learn that $3/5$ can also be interpreted as “3 divided by 5.”</p> <p>Examples:</p> <p>Ten team members are sharing 3 boxes of cookies. How much of a box will each student get? When working this problem a student should recognize that the 3 boxes are being divided into 10 groups, so s/he is seeing the solution to the following equation, $10 \times n = 3$ (10 groups of some amount is 3 boxes) which can also be written as $n = 3 \div 10$. Using models or diagram, they divide each box into 10 groups, resulting in each team member getting $3/10$ of a box.</p> <p>Two afterschool clubs are having pizza parties. For the Math Club, the teacher will order 3 pizzas for every 5 students. For the student council, the teacher will order 5 pizzas for every 8 students. Since you are in both groups, you need to decide which party to attend. How much pizza would you get at each party? If you want to have the most pizza, which party should you attend?</p> <p>The six fifth grade classrooms have a total of 27 boxes of pencils. How many boxes will each classroom receive? Students may recognize this as a whole number division problem but should also express this equal sharing problem as $27/6$. They explain that each classroom gets $27/6$ boxes of pencils and can further determine that each classroom get $4 \frac{3}{6}$ or $4 \frac{1}{2}$ boxes of pencils.</p>

Example:

Your teacher gives 7 packs of paper to your group of 4 students. If you share the paper equally, how much paper does each student get?

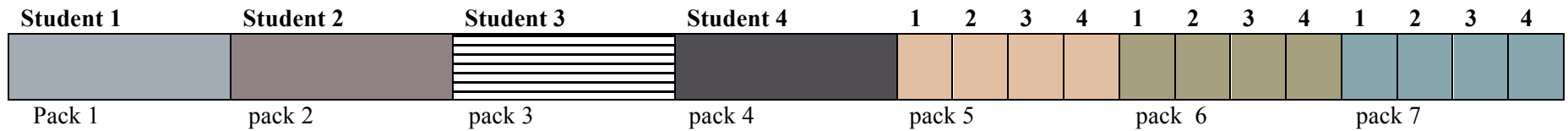

Each student receives 1 whole pack of paper and $\frac{1}{4}$ of the each of the 3 packs of paper. So each student gets $1\frac{3}{4}$ packs of paper.

5.NF.4 Apply and extend previous understandings of multiplication to multiply a fraction or whole number by a fraction.

- a. Interpret the product $(a/b) \times q$ as a parts of a partition of q into b equal parts; equivalently, as the result of a sequence of operations $a \times q \div b$.

For example, use a visual fraction model to show $(2/3) \times 4 = 8/3$, and create a story context for this equation. Do the same with $(2/3) \times (4/5) = 8/15$. (In general, $(a/b) \times (c/d) = ac/bd$.)

Students need to develop a fundamental understanding that the multiplication of a fraction by a whole number could be represented as repeated addition of a unit fraction (e.g., $2 \times (1/4) = 1/4 + 1/4$)

This standard extends student's work of multiplication from earlier grades. In fourth grade, students worked with recognizing that a fraction such as $3/5$ actually could be represented as 3 pieces that are each one-fifth ($3 \times (1/5)$). This standard references both the multiplication of a fraction by a whole number and the multiplication of two fractions. Visual fraction models (area models, tape diagrams, number lines) should be used and created by students during their work with this standard.

As they multiply fractions such as $3/5 \times 6$, they can think of the operation in more than one way.

- $3 \times (6 \div 5)$ or $(3 \times 6)/5$
- $(3 \times 6) \div 5$ or $18 \div 5$ ($18/5$)

Students create a story problem for $3/5 \times 6$ such as,

- Isabel had 6 feet of wrapping paper. She used $3/5$ of the paper to wrap some presents. How much does she have left?
- Every day Tim ran $3/5$ of mile. How far did he run after 6 days? (Interpreting this as $6 \times 3/5$)

Example:

Three-fourths of the class is boys. Two-thirds of the boys are wearing tennis shoes. What fraction of the class are boys with tennis shoes?

This question is asking what $2/3$ of $3/4$ is, or what is $2/3 \times 3/4$. What is $2/3 \times 3/4$, in this case you have $2/3$ groups of size $3/4$ (a way to think about it in terms of the language for whole numbers is 4×5 you have 4 groups of size 5).

The array model is very transferable from whole number work and then to binomials.

Student 1

I drew a rectangle to represent the whole class. The four columns represent the fourths of a class. I shaded 3 columns to represent the fraction that are boys. I then split the rectangle with horizontal lines into thirds. The dark area represents the fraction of the boys in the class wearing tennis shoes, which is 6 out of 12. That is $\frac{6}{12}$, which equals $\frac{1}{2}$.

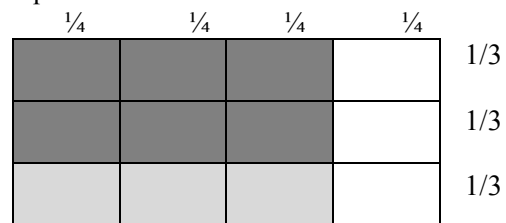

Student 3

Fraction circle could be used to model student thinking. First I shade the fraction circle to show the $\frac{3}{4}$ and then overlay with $\frac{2}{3}$ of that?

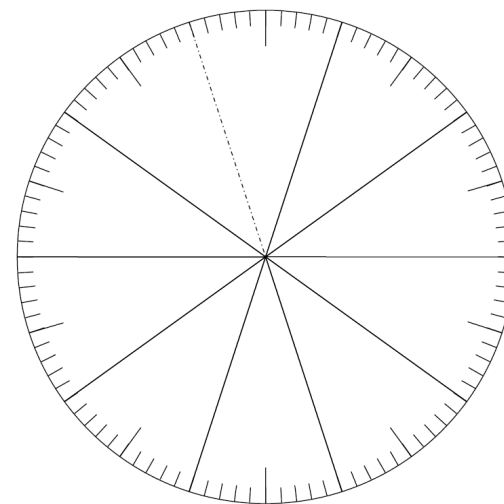

Student 2

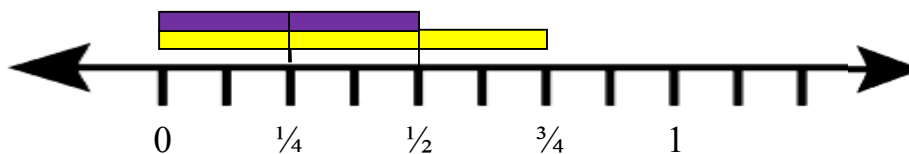

- b. Find the area of a rectangle with fractional side lengths by tiling it with unit squares of the appropriate unit fraction side lengths, and

This standard extends students' work with area. In third grade students determine the area of rectangles and composite rectangles. In fourth grade students continue this work. The fifth grade standard calls students to continue the process of covering (with tiles). Grids (see picture) below can be used to support this work.

show that the area is the same as would be found by multiplying the side lengths. Multiply fractional side lengths to find areas of rectangles, and represent fraction products as rectangular areas.

Example:

The home builder needs to cover a small storage room floor with carpet. The storage room is 4 meters long and half of a meter wide. How much carpet do you need to cover the floor of the storage room? Use a grid to show your work and explain your answer.

In the grid below I shaded the top half of 4 boxes. When I added them together, I added $\frac{1}{2}$ four times, which equals 2. I could also think about this with multiplication $\frac{1}{2} \times 4$ is equal to $\frac{4}{2}$ which is equal to 2.

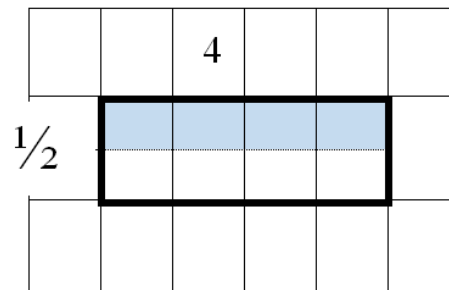

Example:

In solving the problem $\frac{2}{3} \times \frac{4}{5}$, students use an area model to visualize it as a 2 by 4 array of small rectangles each of which has side lengths $\frac{1}{3}$ and $\frac{1}{5}$. They reason that $\frac{1}{3} \times \frac{1}{5} = \frac{1}{(3 \times 5)}$ by counting squares in the entire rectangle, so the area of the shaded area is $(2 \times 4) \times \frac{1}{(3 \times 5)} = \frac{2 \times 4}{3 \times 5}$. They can explain that the product is less than $\frac{4}{5}$ because they are finding $\frac{2}{3}$ of $\frac{4}{5}$. They can further estimate that the answer must be between $\frac{2}{5}$ and $\frac{4}{5}$ because $\frac{2}{3}$ of $\frac{4}{5}$ is more than $\frac{1}{2}$ of $\frac{4}{5}$ and less than one group of $\frac{4}{5}$.

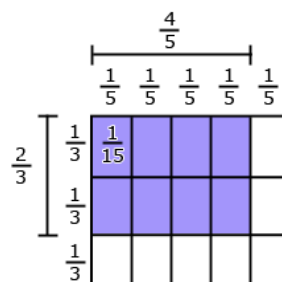

The area model and the line segments show that the area is the same quantity as the product of the side lengths.

5.NF.5 Interpret multiplication as scaling (resizing), by:

- a. Comparing the size of a product to the size of one factor on the basis of the size of the other factor, without performing the indicated multiplication.

This standard calls for students to examine the magnitude of products in terms of the relationship between two types of problems. This extends the work with 5.OA.1.

Example 1:

Mrs. Jones teaches in a room that is 60 feet wide and 40 feet long. Mr. Thomas teaches in a room that is half as wide, but has the same length. How do the dimensions and area of Mr. Thomas' classroom compare to Mrs. Jones' room? Draw a picture to prove your answer.

Example 2:

How does the product of 225×60 compare to the product of 225×30 ? How do you know? Since 30 is half of 60, the product of 225×60 will be double or twice as large as the product of 225×30 .

Example:

$\frac{3}{4} \times 7$ is less than 7 because 7 is multiplied by a factor less than 1 so the product must be less than 7.

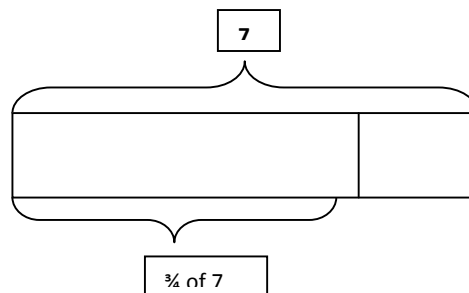

- b. Explaining why multiplying a given number by a fraction greater than 1 results in a product greater than the given number (recognizing multiplication by whole numbers greater than 1 as a familiar case); explaining why multiplying a given

This standard asks students to examine how numbers change when we multiply by fractions. Students should have ample opportunities to examine both cases in the standard: a) when multiplying by a fraction greater than 1, the number increases and b) when multiplying by a fraction less than 1, the number decreases. This standard should be explored and discussed while students are working with 5.NF.4, and should not be taught in isolation.

Example:

Mrs. Bennett is planting two flower beds. The first flower bed is 5 meters long and $\frac{6}{5}$ meters wide. The second flower bed is 5 meters long and $\frac{5}{6}$ meters wide. How do the areas of these two flower beds compare? Is the value of the area larger or smaller than 5 square meters? Draw pictures to prove your answer.

number by a fraction less than 1 results in a product smaller than the given number; and relating the principle of fraction equivalence $a/b = (n \times a)/(n \times b)$ to the effect of multiplying a/b by 1.

Example:

$2\frac{2}{3} \times 8$ is more than 8 because 2 groups of 8 is 16 and $2\frac{2}{3}$ is almost 3 groups of 8. So the answer must be close to, but less than 24.

$\frac{3}{4} = \frac{5 \times 3}{5 \times 4}$ because multiplying $\frac{3}{4}$ by $\frac{5}{5}$ is the same as multiplying by 1.

5.NF.6 Solve real world problems involving multiplication of fractions and mixed numbers, e.g., by using visual fraction models or equations to represent the problem.

This standard builds on all of the work done in this cluster. Students should be given ample opportunities to use various strategies to solve word problems involving the multiplication of a fraction by a mixed number. This standard could include fraction by a fraction, fraction by a mixed number or mixed number by a mixed number.

Example:

There are $2\frac{1}{2}$ bus loads of students standing in the parking lot. The students are getting ready to go on a field trip. $\frac{2}{5}$ of the students on each bus are girls. How many busses would it take to carry **only** the girls?

Student 1

I drew 3 grids and 1 grid represents 1 bus. I cut the third grid in half and I marked out the right half of the third grid, leaving $2\frac{1}{2}$ grids. I then cut each grid into fifths, and shaded two-fifths of each grid to represent the number of girls. When I added up the shaded pieces, $\frac{2}{5}$ of the 1st and 2nd bus were both shaded, and $\frac{1}{5}$ of the last bus was shaded.

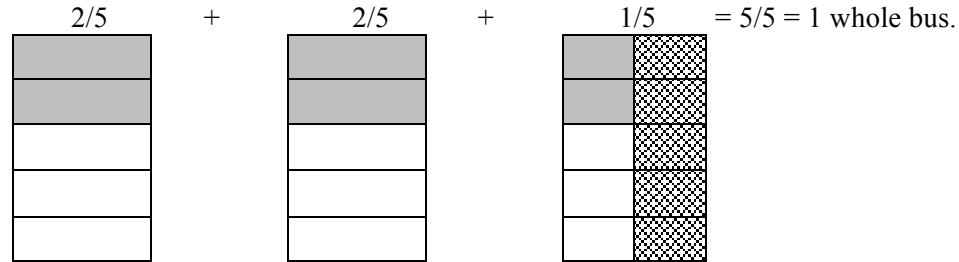

Student 2

$2\frac{1}{2} \times \frac{2}{5} =$
 I split the $2\frac{1}{2}$ into 2 and $\frac{1}{2}$
 $2 \times \frac{2}{5} = \frac{4}{5}$
 $\frac{1}{2} \times \frac{2}{5} = \frac{2}{10}$
 I then added $\frac{4}{5}$ and $\frac{2}{10}$. That equals 1 whole bus load.

Example:

Evan bought 6 roses for his mother. $\frac{2}{3}$ of them were red. How many red roses were there?
Using a visual, a student divides the 6 roses into 3 groups and counts how many are in 2 of the 3 groups.



A student can use an equation to solve.

$$\frac{2}{3} \times 6 = \frac{12}{3} = 4 \text{ red roses}$$

Example:

Mary and Joe determined that the dimensions of their school flag needed to be $1\frac{1}{3}$ ft. by $2\frac{1}{4}$ ft. What will be the area of the school flag?

A student can draw an array to find this product and can also use his or her understanding of decomposing numbers to explain the multiplication. Thinking ahead a student may decide to multiply by $1\frac{1}{3}$ instead of $2\frac{1}{4}$.

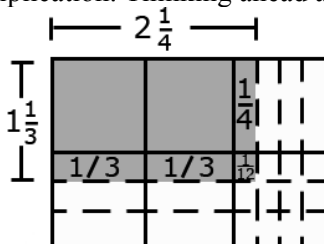

The explanation may include the following:

- First, I am going to multiply $2\frac{1}{4}$ by 1 and then by $\frac{1}{3}$.
- When I multiply $2\frac{1}{4}$ by 1, it equals $2\frac{1}{4}$.
- Now I have to multiply $2\frac{1}{4}$ by $\frac{1}{3}$.
- $\frac{1}{3}$ times 2 is $\frac{2}{3}$.
- $\frac{1}{3}$ times $\frac{1}{4}$ is $\frac{1}{12}$.
- So the answer is $2\frac{1}{4} + \frac{2}{3} + \frac{1}{12}$ or $2\frac{3}{12} + \frac{8}{12} + \frac{1}{12} = 2\frac{12}{12} = 3$

5.NF.7 Apply and extend previous understandings of division to divide unit fractions by whole numbers and whole numbers by unit fractions.¹

a. Interpret division of a unit fraction by a non-zero whole number, and compute such quotients.

For example, create a story context for $(1/3) \div 4$, and use a visual fraction model to show the quotient. Use the relationship between multiplication and division to explain that $(1/3) \div 4 = 1/12$ because $(1/12) \times 4 = 1/3$.

¹ Students able to multiply fractions in general can develop strategies to divide fractions in general, by reasoning about the relationship between multiplication and division. But division of a fraction by a fraction is not a requirement at this grade.

5.NF.7a This standard asks students to work with story contexts where a unit fraction is divided by a non-zero whole number. Students should use various fraction models and reasoning about fractions.

Example:

You have $1/8$ of a bag of pens and you need to share them among 3 people. How much of the bag does each person get?

Student 1
Expression $1/8 \div 3$

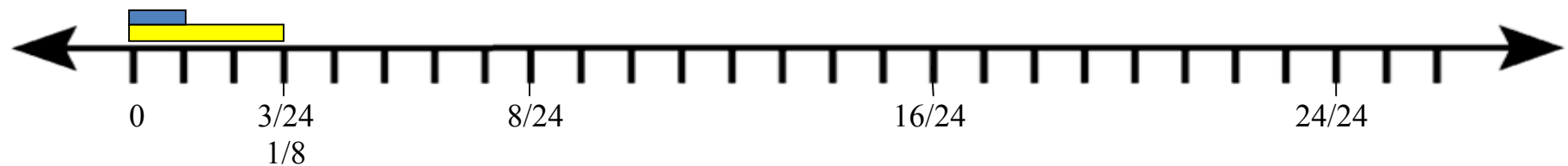

5.NF.7 is the first time that students are dividing with fractions. In fourth grade students divided whole numbers, and multiplied a whole number by a fraction. The concept *unit fraction* is a fraction that has a one in the denominator. For example, the fraction $3/5$ is 3 copies of the unit fraction $1/5$. $1/5 + 1/5 + 1/5 = 3/5 = 1/5 \times 3$ or $3 \times 1/5$

Example:

Knowing the number of groups/shares and finding how many/much in each group/share

Four students sitting at a table were given $1/3$ of a pan of brownies to share. How much of a pan will each student get if they share the pan of brownies equally?

The diagram shows the $1/3$ pan divided into 4 equal shares with each share equaling $1/12$ of the pan.

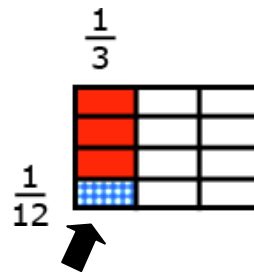

Student 2

I drew a rectangle and divided it into 8 columns to represent my $1/8$. I shaded the first column. I then needed to divide the shaded region into 3 parts to represent sharing among 3 people. I shaded one-third of the first column even darker. The dark shade is $1/24$ of the grid or $1/24$ of the bag of pens.

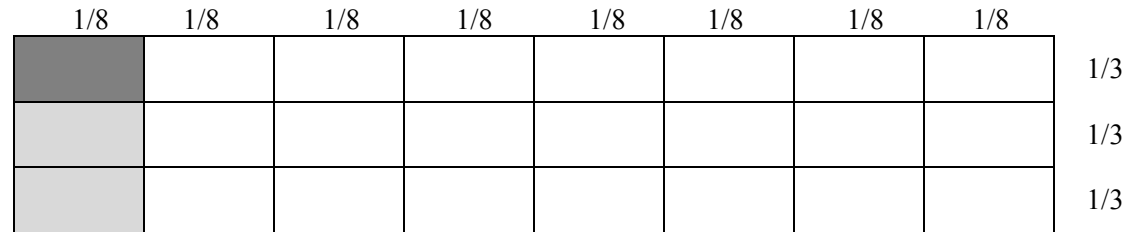

Student 3

$1/8$ of a bag of pens divided by 3 people. I know that my answer will be less than $1/8$ since I'm sharing $1/8$ into 3 groups. I multiplied 8 by 3 and got 24, so my answer is $1/24$ of the bag of pens. I know that my answer is correct because $(1/24) \times 3 = 3/24$ which equals $1/8$.

- b. Interpret division of a whole number by a unit fraction, and compute such quotients. For example, create a story context for $4 \div (1/5)$, and use a visual fraction model to show the quotient. Use the relationship between multiplication and division to explain that $4 \div (1/5) = 20$ because $20 \times (1/5) = 4$.

5.NF.7b This standard calls for students to create story contexts and visual fraction models for division situations where a whole number is being divided by a unit fraction.

Example:

Create a story context for $5 \div 1/6$. Find your answer and then draw a picture to prove your answer and use multiplication to reason about whether your answer makes sense. How many $1/6$ are there in 5?

Student

The bowl holds 5 Liters of water. If we use a scoop that holds $1/6$ of a Liter, how many scoops will we need in order to fill the entire bowl?

I created 5 boxes. Each box represents 1 Liter of water. I then divided each box into sixths to represent the size of the scoop. My answer is the number of small boxes, which is 30. That makes sense since $6 \times 5 = 30$.



$$1 = 1/6 + 1/6 + 1/6 + 1/6 + 1/6 \text{ a whole has } 6/6 \text{ so five wholes would be } 6/6 + 6/6 + 6/6 + 6/6 + 6/6 = 30/6$$

- c. Solve real world problems involving division of unit fractions by non-zero whole numbers and division of whole numbers by unit fractions, e.g., by using visual fraction models and equations to represent the problem.
For example, how much chocolate will each person get if 3 people share $\frac{1}{2}$ lb of chocolate equally? How many $\frac{1}{3}$ -cup servings are 2 cups of raisins?

5.NF.7c extends students' work from other standards in 5.NF.7. Student should continue to use visual fraction models and reasoning to solve these real-world problems.

Example:

How many $\frac{1}{3}$ -cup servings are in 2 cups of raisins?

Student

I know that there are three $\frac{1}{3}$ cup servings in 1 cup of raisins. Therefore, there are 6 servings in 2 cups of raisins. I can also show this since $2 \div \frac{1}{3} = 2 \times 3 = 6$ servings of raisins.

Examples:

Knowing how many in each group/share and finding how many groups/shares

Angelo has 4 lbs of peanuts. He wants to give each of his friends $\frac{1}{5}$ lb. How many friends can receive $\frac{1}{5}$ lb of peanuts?

A diagram for $4 \div \frac{1}{5}$ is shown below. Students explain that since there are five fifths in one whole, there must be 20 fifths in 4 lbs.

1 lb. of peanuts

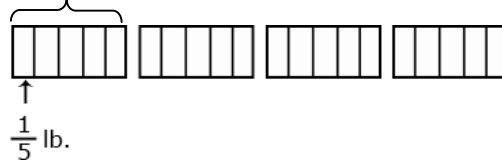

Example:

How much rice will each person get if 3 people share $\frac{1}{2}$ lb of rice equally?

$$\frac{1}{2} \div 3 = \frac{3}{6} \div 3 = \frac{1}{6}$$

A student may think or draw $\frac{1}{2}$ and cut it into 3 equal groups then determine that each of those part is $\frac{1}{6}$.

A student may think of $\frac{1}{2}$ as equivalent to $\frac{3}{6}$. $\frac{3}{6}$ divided by 3 is $\frac{1}{6}$.

Common Core Cluster

Convert like measurement units within a given measurement system.

Mathematically proficient students communicate precisely by engaging in discussion about their reasoning using appropriate mathematical language. The terms students should learn to use with increasing precision with this cluster are: **conversion/convert, metric and customary measurement**
From previous grades: relative size, liquid volume, mass, length, kilometer (km), meter (m), centimeter (cm), kilogram (kg), gram (g), liter (L), milliliter (mL), inch (in), foot (ft), yard (yd), mile (mi), ounce (oz), pound (lb), cup (c), pint (pt), quart (qt), gallon (gal), hour, minute, second

Common Core Standard	Unpacking What do these standards mean a child will know and be able to do?
<p>5.MD.1 Convert among different-sized standard measurement units within a given measurement system (e.g., convert 5 cm to 0.05 m), and use these conversions in solving multi-step, real world problems.</p>	<p>5.MD.1 calls for students to convert measurements within the same system of measurement in the context of multi-step, real-world problems. Both customary and standard measurement systems are included; students worked with both metric and customary units of length in second grade. In third grade, students work with metric units of mass and liquid volume. In fourth grade, students work with both systems and begin conversions within systems in length, mass and volume. Students should explore how the base-ten system supports conversions within the metric system.</p> <p>Example: 100 cm = 1 meter.</p>

Common Core Cluster

Represent and interpret data.

Mathematically proficient students communicate precisely by engaging in discussion about their reasoning using appropriate mathematical language. The terms students should learn to use with increasing precision with this cluster are: **line plot, length, mass, liquid volume**

Common Core Standard	Unpacking What do these standards mean a child will know and be able to do?
<p>5. MD.2 Make a line plot to display a data set of measurements in fractions of a unit ($1/2$, $1/4$, $1/8$). Use operations on fractions for this grade to solve problems involving information presented in line plots. <i>For example, given different measurements of liquid in identical beakers, find the amount of liquid</i></p>	<p>5.MD.2 This standard provides a context for students to work with fractions by measuring objects to one-eighth of a unit. This includes length, mass, and liquid volume. Students are making a line plot of this data and then adding and subtracting fractions based on data in the line plot.</p> <p>Example: Students measured objects in their desk to the nearest $1/2$, $1/4$, or $1/8$ of an inch then displayed data collected on a line plot. How many object measured $1/4$? $1/2$? If you put all the objects together end to end what would be the total length of all the objects?</p>

each beaker would contain if the total amount in all the beakers were redistributed equally.

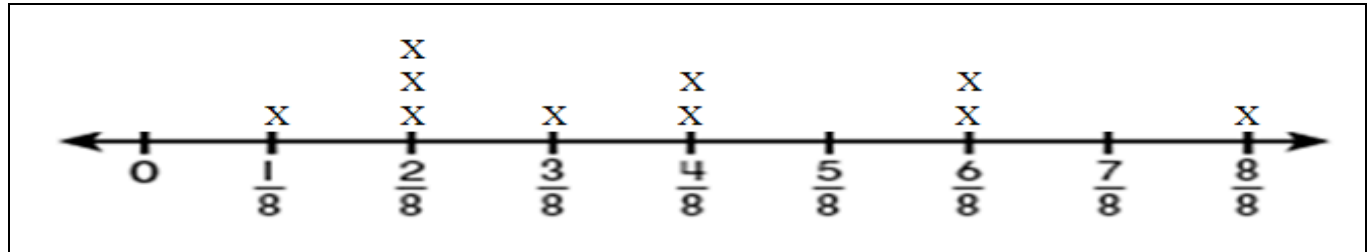

Example:

Ten beakers, measured in liters, are filled with a liquid.

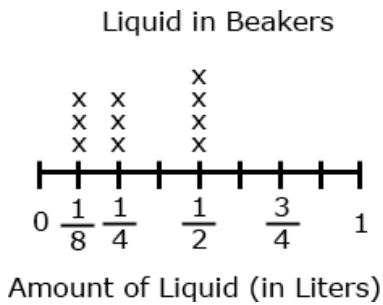

The line plot above shows the amount of liquid in liters in 10 beakers. If the liquid is redistributed equally, how much liquid would each beaker have? (This amount is the mean.)

Students apply their understanding of operations with fractions. They use either addition and/or multiplication to determine the total number of liters in the beakers. Then the sum of the liters is shared evenly among the ten beakers.

Common Core Cluster

Geometric measurement: understand concepts of volume and relate volume to multiplication and to addition.

Students recognize volume as an attribute of three-dimensional space. They understand that volume can be measured by finding the total number of same-size units of volume required to fill the space without gaps or overlaps. They understand that a 1-unit by 1-unit by 1-unit cube is the standard unit for measuring volume. They select appropriate units, strategies, and tools for solving problems that involve estimating and measuring volume. They decompose three-dimensional shapes and find volumes of right rectangular prisms by viewing them as decomposed into layers of arrays of cubes. They measure necessary attributes of shapes in order to determine volumes to solve real world and mathematical problems.

Mathematically proficient students communicate precisely by engaging in discussion about their reasoning using appropriate mathematical language. The terms students should learn to use with increasing precision with this cluster are: **measurement, attribute, volume, solid figure, right rectangular prism, unit, unit cube, gap, overlap, cubic units (cubic cm, cubic in. cubic ft. nonstandard cubic units), multiplication, addition, edge lengths, height, area of base**

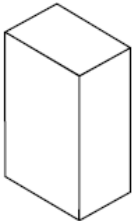
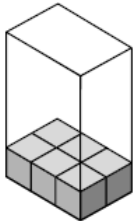
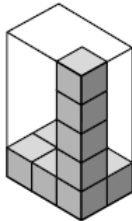
Common Core Standard	Unpacking What do these standards mean a child will know and be able to do?
<p>5. MD.3 Recognize volume as an attribute of solid figures and understand concepts of volume measurement.</p> <p>a. A cube with side length 1 unit, called a “unit cube,” is said to have “one cubic unit” of volume, and can be used to measure volume.</p> <p>b. A solid figure which can be packed without gaps or overlaps using n unit cubes is said to have a volume of n cubic units.</p>	<p>5. MD.3, 5.MD.4, and 5. MD.5 These standards represent the first time that students begin exploring the concept of volume. In third grade, students begin working with area and covering spaces. The concept of volume should be extended from area with the idea that students are covering an area (the bottom of cube) with a layer of unit cubes and then adding layers of unit cubes on top of bottom layer (see picture below). Students should have ample experiences with concrete manipulatives before moving to pictorial representations. Students’ prior experiences with volume were restricted to liquid volume. As students develop their understanding volume they understand that a 1-unit by 1-unit by 1-unit cube is the standard unit for measuring volume. This cube has a length of 1 unit, a width of 1 unit and a height of 1 unit and is called a cubic unit. This cubic unit is written with an exponent of 3 (e.g., in^3, m^3). Students connect this notation to their understanding of powers of 10 in our place value system. Models of cubic inches, centimeters, cubic feet, etc are helpful in developing an image of a cubic unit. Students estimate how many cubic yards would be needed to fill the classroom or how many cubic centimeters would be needed to fill a pencil box.</p>
<p>5. MD.4 Measure volumes by counting unit cubes, using cubic cm, cubic in, cubic ft, and improvised units.</p>	<div style="display: flex; align-items: center; justify-content: center;"> <div style="text-align: center;">  </div> <div style="margin: 0 20px;">  <p>one layer</p> </div> <div style="margin: 0 20px;">  <p>five layers fill the box</p> </div> <div style="margin-left: 20px;"> <p>(3×2) represented by first layer $(3 \times 2) \times 5$ represented by number of 3×2 layers $(3 \times 2) + (3 \times 2) + (3 \times 2) + (3 \times 2) + (3 \times 2) = 6 + 6 + 6 + 6 + 6 = 30$ 6 representing the size/area of one layer</p> </div> </div>
<p>5. MD.5 Relate volume to the operations of multiplication and addition and solve real world and mathematical problems involving volume.</p> <p>a. Find the volume of a right rectangular prism with whole-</p>	

number side lengths by packing it with unit cubes, and show that the volume is the same as would be found by multiplying the edge lengths, equivalently by multiplying the height by the area of the base. Represent threefold whole-number products as volumes, e.g., to represent the associative property of multiplication.

b. Apply the formulas $V = l \times w \times h$ and $V = b \times h$ for rectangular prisms to find volumes of right rectangular prisms with whole-number edge lengths in the context of solving real world and mathematical problems.

c. Recognize volume as additive. Find volumes of solid figures composed of two non-overlapping right rectangular prisms by adding the volumes of the non-overlapping parts, applying this technique to solve real world problems.

5. MD.5a & b These standards involve finding the volume of right rectangular prisms (see picture above). Students should have experiences to describe and reason about why the formula is true. Specifically, that they are covering the bottom of a right rectangular prism (length x width) with multiple layers (height). Therefore, the formula (length x width x height) is an extension of the formula for the area of a rectangle.

5. MD.5c This standard calls for students to extend their work with the area of composite figures into the context of volume. Students should be given concrete experiences of breaking apart (decomposing) 3-dimensional figures into right rectangular prisms in order to find the volume of the entire 3-dimensional figure.

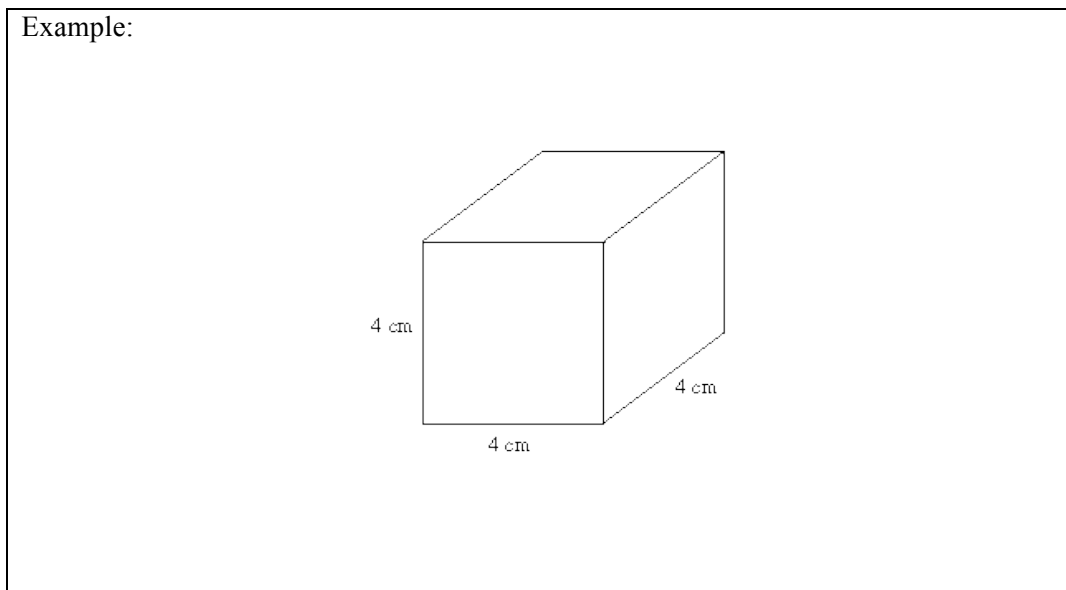
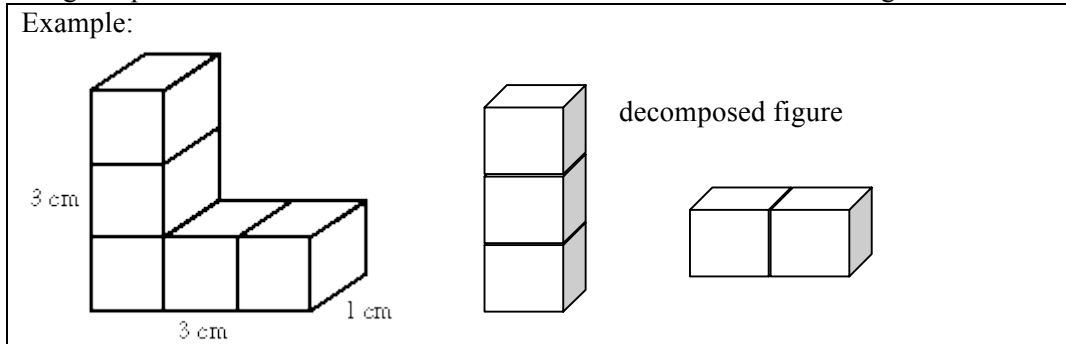

Example:

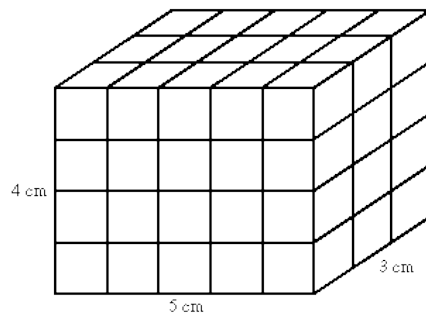

Students need multiple opportunities to measure volume by filling rectangular prisms with cubes and looking at the relationship between the total volume and the area of the base. They derive the volume formula (volume equals the area of the base times the height) and explore how this idea would apply to other prisms. Students use the associative property of multiplication and decomposition of numbers using factors to investigate rectangular prisms with a given number of cubic units.

Example:

When given 24 cubes, students make as many rectangular prisms as possible with a volume of 24 cubic units. Students build the prisms and record possible dimensions.

Length	Width	Height
1	2	12
2	2	6
4	2	3
8	3	1

Example:

Students determine the volume of concrete needed to build the steps in the diagram below.

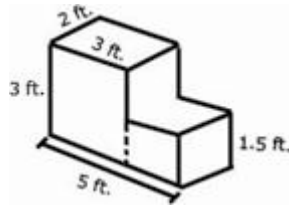

Geometry

5.G

Common Core Cluster

Graph points on the coordinate plane to solve real-world and mathematical problems.

Mathematically proficient students communicate precisely by engaging in discussion about their reasoning using appropriate mathematical language. The terms students should learn to use with increasing precision with this cluster are: **coordinate system, coordinate plane, first quadrant, points, lines, axis/axes, x-axis, y-axis, horizontal, vertical, intersection of lines, origin, ordered pairs, coordinates, x-coordinate, y-coordinate**

Common Core Standard

5.G.1 Use a pair of perpendicular number lines, called axes, to define a coordinate system, with the intersection of the lines (the origin) arranged to coincide with the 0 on each line and a given point in the plane located by using an ordered pair of numbers, called its coordinates. Understand that the first number indicates how far to travel from the origin in the direction of one axis, and the second number indicates how far to travel in the direction of the second axis, with the convention that the names of the two axes and the coordinates correspond (e.g., x -axis and x -coordinate, y -axis and y -coordinate).

Unpacking

What do these standards mean a child will know and be able to do?

5.G.1 and 5.G.2 These standards deal with only the first quadrant (positive numbers) in the coordinate plane.

Example:

Connect these points in order on the coordinate grid below:
 (2, 2) (2, 4) (2, 6) (2, 8) (4, 5) (6, 8) (6, 6) (6, 4) and (6, 2).

Coordinate Grid

What letter is formed on the grid?

Solution: "M" is formed.

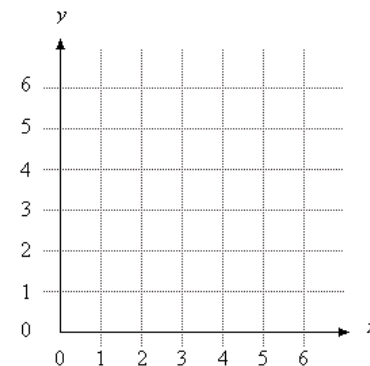

	<div data-bbox="802 142 1774 617" style="border: 1px solid black; padding: 5px;"> <p>Example: Plot these points on a coordinate grid.</p> <p style="padding-left: 40px;">Point A: (2,6) Point B: (4,6) Point C: (6,3) Point D: (2,3)</p> <p>Connect the points in order. Make sure to connect Point D back to Point A.</p> <ol style="list-style-type: none"> 1. What geometric figure is formed? What attributes did you use to identify it? 2. What line segments in this figure are parallel? 3. What line segments in this figure are perpendicular? <p><i>solutions: trapezoid, line segments AB and DC are parallel, segments AD and DC are perpendicular</i></p> </div> <div data-bbox="802 646 1774 779" style="border: 1px solid black; padding: 5px; margin-top: 10px;"> <p>Example: Emanuel draws a line segment from (1, 3) to (8, 10). He then draws a line segment from (0, 2) to (7, 9). If he wants to draw another line segment that is parallel to those two segments what points will he use?</p> </div>
<p>5.G.2 Represent real world and mathematical problems by graphing points in the first quadrant of the coordinate plane, and interpret coordinate values of points in the context of the situation.</p>	<p>5.G.2 references real-world and mathematical problems, including the traveling from one point to another and identifying the coordinates of missing points in geometric figures, such as squares, rectangles, and parallelograms.</p>

Example:
 Using the coordinate grid, which ordered pair represents the location of the School?
 Explain a possible path from the school to the library.

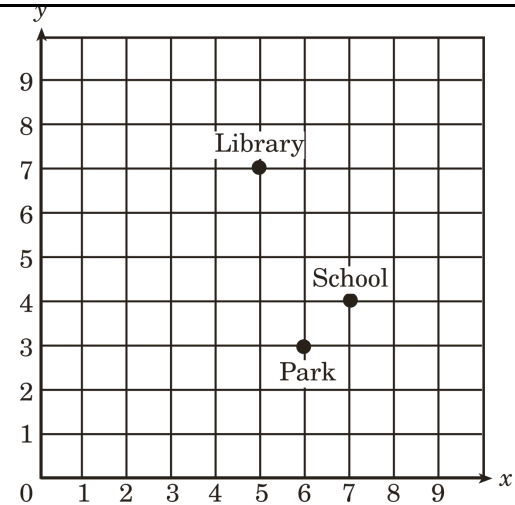

Example:
 Sara has saved \$20. She earns \$8 for each hour she works.
 If Sara saves all of her money, how much will she have after working 3 hours? 5 hours? 10 hours?
 Create a graph that shows the relationship between the hours Sara worked and the amount of money she has saved.
 What other information do you know from analyzing the graph?
 Use the graph below to determine how much money Jack makes after working exactly 9 hours.

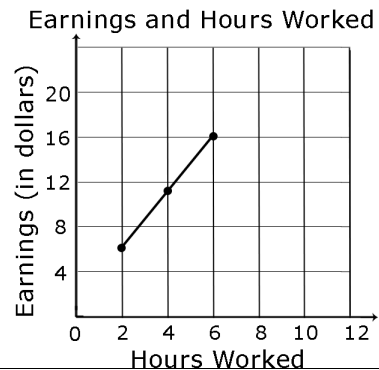

Classify two-dimensional figures into categories based on their properties.

Mathematically proficient students communicate precisely by engaging in discussion about their reasoning using appropriate mathematical language. The terms students should learn to use with increasing precision with this cluster are: **attribute, category, subcategory, hierarchy, (properties)-rules about how numbers work, two dimensional**

From previous grades: polygon, rhombus/rhombi, rectangle, square, triangle, quadrilateral, pentagon, hexagon, cube, trapezoid, half/quarter circle, circle

Common Core Standard	Unpacking
<p>5.G.3 Understand that attributes belonging to a category of two-dimensional figures also belong to all subcategories of that category. <i>For example, all rectangles have four right angles and squares are rectangles, so all squares have four right angles.</i></p>	<p>What do these standards mean a child will know and be able to do?</p> <p>This standard calls for students to reason about the attributes (properties) of shapes. Student should have experiences discussing the property of shapes and reasoning.</p> <p>Example: Examine whether all quadrilaterals have right angles. Give examples and non-examples.</p> <p>Example: If the opposite sides on a parallelogram are parallel and congruent, then rectangles are parallelograms</p> <p>A sample of questions that might be posed to students include: A parallelogram has 4 sides with both sets of opposite sides parallel. What types of quadrilaterals are parallelograms? Regular polygons have all of their sides and angles congruent. Name or draw some regular polygons. All rectangles have 4 right angles. Squares have 4 right angles so they are also rectangles. True or False? A trapezoid has 2 sides parallel so it must be a parallelogram. True or False?</p> <p>http://illuminations.nctm.org/ActivityDetail.aspx?ID=70</p>
<p>5.G.4 Classify two-dimensional figures in a hierarchy based on properties.</p>	<p>This standard builds on what was done in 4th grade. Figures from previous grades: polygon, rhombus/rhombi, rectangle, square, triangle, quadrilateral, pentagon, hexagon, cube, trapezoid, half/quarter circle, circle</p> <p>Example: Create a Hierarchy Diagram using the following terms:</p> <div style="display: flex; justify-content: space-between;"> <div data-bbox="646 1214 1247 1422" style="border: 1px solid black; padding: 5px;"> <p>polygons – a closed plane figure formed from line segments that meet only at their endpoints. quadrilaterals - a four-sided polygon. rectangles - a quadrilateral with two pairs of</p> </div> <div data-bbox="1283 1214 1883 1422" style="border: 1px solid black; padding: 5px; text-align: center;"> <p>Possible student solution:</p> <p style="font-size: 1.5em;">Polygons</p> <p>▼</p> </div> </div>

congruent parallel sides and four right angles.
 rhombi – a parallelogram with all four sides equal in length.
 square – a parallelogram with four congruent sides and four right angles.

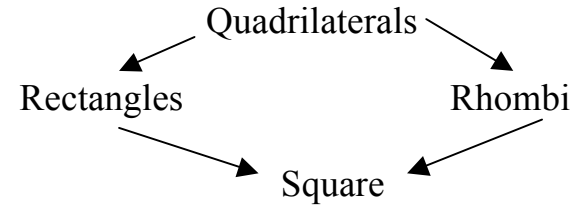

quadrilateral – a four-sided polygon.
 parallelogram – a quadrilateral with two pairs of parallel and congruent sides.
 rectangle – a quadrilateral with two pairs of congruent, parallel sides and four right angles.
 rhombus – a parallelogram with all four sides equal in length.
 square – a parallelogram with four congruent sides and four right angles.

Possible student solution:

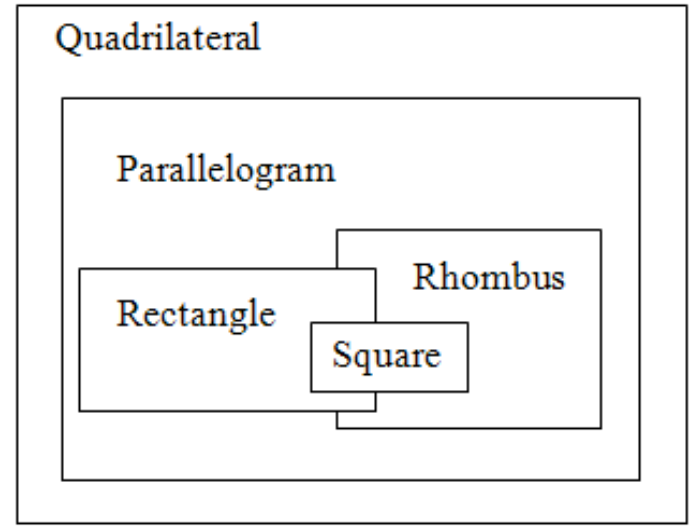

Student should be able to reason about the attributes of shapes by examining: What are ways to classify triangles? Why can't trapezoids and kites be classified as parallelograms? Which quadrilaterals have opposite angles congruent and why is this true of certain quadrilaterals?, and How many lines of symmetry does a regular polygon have?

Some examples used in this document are from the Arizona Mathematics Education Department

Glossary

Table 1 Common addition and subtraction situations¹

	Result Unknown	Change Unknown	Start Unknown
Add to	Two bunnies sat on the grass. Three more bunnies hopped there. How many bunnies are on the grass now? $2 + 3 = ?$	Two bunnies were sitting on the grass. Some more bunnies hopped there. Then there were five bunnies. How many bunnies hopped over to the first two? $2 + ? = 5$	Some bunnies were sitting on the grass. Three more bunnies hopped there. Then there were five bunnies. How many bunnies were on the grass before? $? + 3 = 5$
	Five apples were on the table. I ate two apples. How many apples are on the table now? $5 - 2 = ?$	Five apples were on the table. I ate some apples. Then there were three apples. How many apples did I eat? $5 - ? = 3$	Some apples were on the table. I ate two apples. Then there were three apples. How many apples were on the table before? $? - 2 = 3$
	Total Unknown	Addend Unknown	Both Addends Unknown²
Put Together/ Take Apart³	Three red apples and two green apples are on the table. How many apples are on the table? $3 + 2 = ?$	Five apples are on the table. Three are red and the rest are green. How many apples are green? $3 + ? = 5, 5 - 3 = ?$	Grandma has five flowers. How many can she put in her red vase and how many in her blue vase? $5 = 0 + 5, 5 = 5 + 0$ $5 = 1 + 4, 5 = 4 + 1$ $5 = 2 + 3, 5 = 3 + 2$
	Difference Unknown	Bigger Unknown	Smaller Unknown
Compare⁴	(“How many more?” version): Lucy has two apples. Julie has five apples. How many more apples does Julie have than Lucy?	(Version with “more”): Julie has three more apples than Lucy. Lucy has two apples. How many apples does Julie have?	(Version with “more”): Julie has three more apples than Lucy. Julie has five apples. How many apples does Lucy have?
	(“How many fewer?” version): Lucy has two apples. Julie has five apples. How many fewer apples does Lucy have than Julie? $2 + ? = 5, 5 - 2 = ?$	(Version with “fewer”): Lucy has 3 fewer apples than Julie. Lucy has two apples. How many apples does Julie have? $2 + 3 = ?, 3 + 2 = ?$	(Version with “fewer”): Lucy has 3 fewer apples than Julie. Julie has five apples. How many apples does Lucy have? $5 - 3 = ?, ? + 3 = 5$

²These take apart situations can be used to show all the decompositions of a given number. The associated equations, which have the total on the left of the equal sign, help children understand that the = sign does not always mean makes or results in but always does mean is the same number as.

³Either addend can be unknown, so there are three variations of these problem situations. Both Addends Unknown is a productive extension of this basic situation, especially for small numbers less than or equal to 10.

⁴For the Bigger Unknown or Smaller Unknown situations, one version directs the correct operation (the version using more for the bigger unknown and using less for the smaller unknown). The other versions are more difficult.

¹Adapted from Box 2-4 of Mathematics Learning in Early Childhood, National Research Council (2009, pp. 32, 33).

Table 2 Common multiplication and division situations¹

	Unknown Product $3 \times 6 = ?$	Group Size Unknown ("How many in each group?" Division) $3 \times ? = 18$, and $18 \div 3 = ?$	Number of Groups Unknown ("How many groups?" Division) $? \times 6 = 18$, and $18 \div 6 = ?$
Equal Groups	<p>There are 3 bags with 6 plums in each bag. How many plums are there in all?</p> <p><i>Measurement example.</i> You need 3 lengths of string, each 6 inches long. How much string will you need altogether?</p>	<p>If 18 plums are shared equally into 3 bags, then how many plums will be in each bag?</p> <p><i>Measurement example.</i> You have 18 inches of string, which you will cut into 3 equal pieces. How long will each piece of string be?</p>	<p>If 18 plums are to be packed 6 to a bag, then how many bags are needed?</p> <p><i>Measurement example.</i> You have 18 inches of string, which you will cut into pieces that are 6 inches long. How many pieces of string will you have?</p>
Arrays, ² Area ³	<p>There are 3 rows of apples with 6 apples in each row. How many apples are there?</p> <p><i>Area example.</i> What is the area of a 3 cm by 6 cm rectangle?</p>	<p>If 18 apples are arranged into 3 equal rows, how many apples will be in each row?</p> <p><i>Area example.</i> A rectangle has area 18 square centimeters. If one side is 3 cm long, how long is a side next to it?</p>	<p>If 18 apples are arranged into equal rows of 6 apples, how many rows will there be?</p> <p><i>Area example.</i> A rectangle has area 18 square centimeters. If one side is 6 cm long, how long is a side next to it?</p>
Compare	<p>A blue hat costs \$6. A red hat costs 3 times as much as the blue hat. How much does the red hat cost?</p> <p><i>Measurement example.</i> A rubber band is 6 cm long. How long will the rubber band be when it is stretched to be 3 times as long?</p>	<p>A red hat costs \$18 and that is 3 times as much as a blue hat costs. How much does a blue hat cost?</p> <p><i>Measurement example.</i> A rubber band is stretched to be 18 cm long and that is 3 times as long as it was at first. How long was the rubber band at first?</p>	<p>A red hat costs \$18 and a blue hat costs \$6. How many times as much does the red hat cost as the blue hat?</p> <p><i>Measurement example.</i> A rubber band was 6 cm long at first. Now it is stretched to be 18 cm long. How many times as long is the rubber band now as it was at first?</p>
General	$a \times b = ?$	$a \times ? = p$, and $p \div a = ?$	$? \times b = p$, and $p \div b = ?$

²The language in the array examples shows the easiest form of array problems. A harder form is to use the terms rows and columns: The apples in the grocery window are in 3 rows and 6 columns. How many apples are in there? Both forms are valuable.

³Area involves arrays of squares that have been pushed together so that there are no gaps or overlaps, so array problems include these especially important measurement situations.

¹The first examples in each cell are examples of discrete things. These are easier for students and should be given before the measurement examples.

Table 3 The properties of operations

Here a , b and c stand for arbitrary numbers in a given number system. The properties of operations apply to the rational number system, the real number system, and the complex number system.

<i>Associative property of addition</i>	$(a + b) + c = a + (b + c)$
<i>Commutative property of addition</i>	$a + b = b + a$
<i>Additive identity property of 0</i>	$a + 0 = 0 + a = a$
<i>Associative property of multiplication</i>	$(a \times b) \times c = a \times (b \times c)$
<i>Commutative property of multiplication</i>	$a \times b = b \times a$
<i>Multiplicative identity property of 1</i>	$a \times 1 = 1 \times a = a$
<i>Distributive property of multiplication over addition</i>	$a \times (b + c) = a \times b + a \times c$